

TOTO

**TOTO ASIA OCEANIA
PTE. LTD.**

10, Eunos Road 8, #12-07, Singapore Post Centre. Singapore 408600.
Phone : +65-6744-6955 Fax : +65-6841-0819 <http://asia.toto.com/>

**TOTO ASIA OCEANIA
PTE. LTD.**

Middle East Branch LOB19-1701,02, Jebel Ali Free Zone, P.O. box 261804, Dubai U.A.E.
Phone : +971-4-886-5983 Fax : +971-4-886-5986 <http://asia.toto.com/>

**TOTO ASIA OCEANIA
PTE. LTD.**

Manila Representative Office. Unit 706, Rufino Building, Ayala Avenue Corner V.A.
Rufino Street, Makati City, 1226, Philippines.
Phone : +63-2-8887-6643 Fax : +63-2-887-4084 <http://asia.toto.com/>

**TOTO ASIA OCEANIA
PTE. LTD.**

Yangon Branch # 0608 Sakura Tower, 339 Bogyoke Aung San Rd,
Kyauktada Township, Yangon, Myanmar
<http://asia.toto.com/>

**TOTO INDIA INDUSTRIES
PVT. LTD**

1002, Kamla Executive Park, Opposite Vazir Glass Works,
Andheri Kurla Road, Andheri (E), Mumbai-400059. Maharashtra, India.
Phone : +91-22-43112-111/112 Fax : +91-22-28325741/42 Hotline : +91-18001027088
<https://in.toto.com/>

**TOTO VIETNAM
Co., Ltd.**

Lot F-1, F-2, F-3, F-4 Thang Long industrial park, Dong Anh Dist, Ha Noi, Vietnam
Phone: +84-24-38811926 Fax: +84-24-38811928 Hotline: 1800558830
<http://vn.toto.com>

TOTO (H.K.)LTD.

RM.1101, 11/F No.3 Lockhart Rd. Wanchai, Hong Kong
Phone : +852-2861-3177 Fax : +852-2861-3563
<https://hk.toto.com>

- You are advised to record the following information to allow quick service.

Date of purchase :	Name of shop :
Date : year month day	Tel : ()

 This code is for manufacturer management use.

2024.7.24
D07L34

TOTO

NEOREST RS

Instruction Manual

If the water does not flow due to a power outage. (→Page 49)



NEOREST

TCF83410***



**Thank you for your recent purchase of this product.
Please read the enclosed information to ensure the safe use of your product.**

Be sure to read this Instruction Manual before using your product and keep it in a safe place for future reference.

Table of Contents

Introduction	
Safety Precautions	4
Operational Precautions	8
Parts Names	10
Preparation	12
Using the Product for the First Time.....	12
Operation	
Basic Operations	14
Mechanism of Auto Functions	14
Auto open / close.....	14
Deodorizer	14
Auto bowl CLEAN	14
Auto power deodorizer.....	14
Auto flushing.....	14
Auto wand CLEAN	14
Soft light	16
CLEAN indicator	16
Using the Remote Control	17
Stop	17
Rear washing.....	17
Rear soft washing	17
Front washing	17
Warm air drying	17
Water pressure adjustment.....	17
Wand position adjustment.....	17
Pulsating washing.....	17
Oscillating washing.....	17
Wand CLEAN	18
Power dedorizer	18
Full flush	18
Light flush	18
Opening and closing the toilet lid	18
Opening and closing the toilet seat	18
Personal setting.....	18
Low battery warning mark.....	18
Power ON/OFF button	19
Wand cleaning	19
Bowl unit cleaning.....	19
Manual spray	19
Warm water temperature	19
Toilet seat temperature	19
Drying air temperature	19
Auto energy saver / Auto energy saver+	19
Timer energy saver.....	19

Auto open / close ON / OFF.....	19
Setting confirmation	19
Auto flushing ON / OFF.....	19
Temperature Adjustment	20
Warm water / Toilet seat / Drying	20
Changing Settings	22
Setting List	22
The energy saver features.....	24
How to Set.....	26
Auto energy saver.....	26
Auto energy saver+.....	26
Timer energy saver	27
Auto flushing.....	27
Auto flush delay	28
Auto flush lid closed.....	28
Auto open / close	30
Auto close delay	30
Auto open delay.....	31
Seat/lid	31
Auto wand CLEAN	32
Auto bowl CLEAN	32
Deodorizer.....	33
Auto power deodorizer.....	33
Night light	34
Soft light	35
Bowl light.....	35
CLEAN indicator	36
Anti freezing	36
Beep sound	37
Lower water level.....	37
Pressure/position setting	38
Personal setting.....	38
Registering Personal Settings.....	39

Maintenance	
Maintenance	40
Before Maintenance	40
Top Unit.....	41
Bowl Unit	42
Bowl unit cleaning.....	42
Manual Spray	42
Gap between the Top Unit and Bowl Unit.....	43
Gap between the Top Unit and the Toilet Lid	44
Wand	45
Wand cleaning	45
Deodorizing Filter	46
Drain Plug With Water Supply Filter.....	47
Water Supply Filter (Bowl Unit).....	48

Reference	
What to Do?	49
If the water does not flow due to a power outage (when water failure hasn't occurred)	49
If the water does not flow due to a water service interruption	51
If you cannot operate with the remote control	51
Replacing the batteries	52
Freeze Damage Prevention	52
Long Periods of Disuse.....	53
How to drain the water.....	53
Resupplying the Water.....	54
How to remove the operation guide	55
Troubleshooting	56
Please check first	56
Rear Washing, Front Washing and Wand	57
Warm air drying	58
Flushing	58
Toilet Seat and Toilet Lid (Auto open/close)	60
Toilet Seat and Toilet Lid	62
Auto flush lid closed.....	63
Energy Saver.....	63
Deodorizer.....	64
Auto bowl CLEAN	64
Lights	64
Others	65
Specifications	67
Safety Guidelines	70
Limited Warranty	71

Safety Precautions

These precautions are important for safe usage. Be sure to follow them and use the product correctly. The following symbols are used to indicate important safety instructions for the use of the product.

Symbols and Meanings

 **WARNING** May result in death or serious injury.

 **CAUTION** May result in injury or property damage.

WARNING

Never disassemble, repair or alter.

Doing so may cause fire, electrical shock, overheating, short circuit or breakdown.

Do not use the product if a malfunction occurs.

In case of breakdown or other problem, be sure to cut off power by means such as unplugging the power plug.

Close the water shutoff valve to stop water supply. Possible malfunctions:

- Water is leaking from a pipe or the top unit.
- The product is cracked or broken.
- The product makes a strange noise or emits a strange odor.
- The product emits smoke.
- The product is abnormally hot.
- The bowl unit is clogged.
- The toilet seat cushion is out of place.

Continued use after malfunction could cause a fire, electrical shock, heat, short circuit, injury or water damage.

Do not use other water than allowed by the laws and ordinances of the region of use. Only Use potable water.

Do not use seawater or recycled water.

Doing so may cause irritation to the skin and malfunction.

Keep cigarettes and other open flames away from the product.

Failure to do so may cause fire.

Refrain from sitting on the seat for long periods.

It may cause low-temperature burns.

To prevent the following persons from getting a moderate temperature burn during use, other person should turn off the toilet seat heater and set the dryer temperature to "Low".

- Young children, the aged and other users unable to set the temperature appropriately themselves.
- The ill, physically disabled and others who do not have freedom of movement.
- Those using any medicines that cause drowsiness (sleeping or cold medicine), those who have been drinking heavily, anyone severely fatigued and anyone else liable to fall asleep.

If the power cord is damaged, avoid danger by having the manufacturer's repair department or equivalent specialist replace it.

Turn the power OFF before maintenance or inspection.*1

Failure to do so may cause electrical shock or malfunction.

When leaking battery fluid adheres to your body or clothes, wash it away with clean water.

The fluid may damage your eyes or skin.

Do not stick a finger or anything else into the warm air outlet.

Do not place anything on the warm air outlet or drape clothes over it.

Doing so may cause burns, electrical shock or malfunction.

WARNING

Do not install the product on moving vehicles such as wheeled vehicles or boats.

Doing so may cause fire, electric shock, short circuit or malfunction.

The toilet seat, toilet lid, top unit, or other parts may come loose and fall off, resulting in injury.

Do not use any power supply other than the one specified.

AC 220–240 V, 50 / 60 Hz

Doing so may cause fire or excessive heat.

This is an electrical product. Do not install it anywhere water is likely to get on the product or anywhere with humidity high enough that water is likely to form on the surface of this product. When using the product in a bathroom, install a fan or ventilation port and ensure good air flow through the bathroom.

Failure to do so may cause fire or electrical shock.

Always connect the product to the cold water supply.

Connecting to hot water supply may result in burns and equipment damage.

Preliminary studies in females suggest that overuse of continuous spraying can increase the possibility of vaginal mucosa drying and potential reduction in desirable microbial organisms. Although these studies have not been validated, please consult your healthcare provider for concerns regarding whether these circumstances may apply to you.

More importantly, if you are an individual suffering from any immune deficiency as a result of disease, chemotherapy, or other medical condition compromising the immune system you should consult your healthcare provider before use of this product.

This appliance is not intended for use by persons (including children) with reduced physical, sensory or mental capabilities, or lack of experience and knowledge, unless they have been given supervision or instruction concerning use of the appliance by a person responsible for their safety. Children should be supervised to ensure that they do not play with the appliance.

Do not touch the connection of power cord with wet hands.

Doing so may cause electrical shock.

Do not get any water or cleaning solution on the gap between the top unit and bowl unit or power supply connections.

Doing so may cause fire, electrical shock, heat or short circuit.

Doing so may cause the product to crack resulting in injury or water damage.

Do not touch the power source connection during thunderstorms.

Doing so may cause electrical shock.

Do not allow the water supply hose to touch the power source connection.

Doing so may cause condensation resulting in a fire, electrical shock, heat or a short.

Do not do anything that may damage the power cord or power source connection.

Do not strike, yank, twist, excessively bend, damage, alter, or heat the power cords. Also, do not place anything heavy on, bind or pinch the power cords.

Using a damaged power cord may result in a fire, electrical shock, heat or short.

Confirm that a properly grounded outlet² or terminal block³ has been installed.

Failure to install a grounded outlet could cause electrical shock in the event of a malfunction.

*If there is no ground installed, ask the contractor who did the installation to install the ground.

*1 How to turn off the product. (→Page 13)

*2 If the product has a power plug.

*3 If the product does not have a power plug.

Safety Precautions

WARNING

Do not use a loose or faulty electrical outlet.*¹

Doing so may cause fire or short circuit.

Do not use any outlet beyond its specified rating.*¹

Plugging too many plugs into the same outlet, for example using outlet splitters, can cause fire due to heat.

Insert the power plug securely into the outlet.*¹

Failure to do so may cause fire, heat or short circuit.

Check that the power plug is waterproofed with silicone rubber.*¹

A power plug that is not water-proofed may cause fire and electrical shock.

*If the power plug is not water-proofed, ask the contractor who did the installation to water-proof it.

To unplug, hold the power plug, not the power cord.*¹

Do not unplug by pulling the power cord.*¹

Pulling on the power cord may cause damage and result in fire or heat.

CAUTION

Do not use the product if the top unit is unstable.

Doing so may cause the top unit to come loose and fall, resulting in injury.

If the product is damaged, do not touch the damaged section.

Doing so may cause electrical shock or injury. Replace it immediately.

Do not use the product while the top unit is lifted up by the cleaning lift.

When lowering the top unit by the cleaning lift, do not insert your fingers into the gap between the top unit and the bowl unit.

Do not apply strong force, mechanical shock, step on or stand on the toilet seat, toilet lid or top unit. Also do not place any heavy object on the toilet seat, toilet lid or top unit.

Doing so may cause cracking or cause the top unit to come loose and fall, resulting in injury.

Doing so may damage the product and cause injury or water damage.

When maintaining the plastic parts (top unit etc.) or the water supply hose, use a pH neutral kitchen detergent diluted with water. Do not use any of the following.

Toilet cleaner, household cleaner, benzene, paint thinner, powdered cleanser or nylon scrubbing brush.

These items may damage or crack the plastic and cause injury or malfunction.

These items could damage the water supply hose and cause a water leak.

To prevent a sudden water leak, do not remove the drain plug with water supply filter when the shutoff valve is open.

Doing so will cause water to spurt out.

(→Refer to Page 47 for instructions on cleaning the drain plug with water supply filter.)

CAUTION

Do not fold or crush the water supply hose; do not damage by cutting with a sharp object.

Doing so may cause water leaks.

Do not pour hot water into the toilet.

Doing so may result in damage to the toilet, injury or water damage.

Keep the bowl filled with water.

Failure to do so may cause sewer gas, chlorine gas, or hydrogen sulfide to corrode facilities and equipment.

Do not flush anything other than bodily waste and toilet paper. Also, do not flush too much toilet paper. Do not flush the bowl unit if it is clogged.

Doing so may clog the toilet, causing waste water overflow, and water damage.

Always flush, even after just urinating.

Failure to do so may clog the toilet, causing waste water overflow and water damage or inadequate flushing of the bowl unit.

Wipe any urine, condensation, cleaner, water, etc. that has gotten on the floor with a well-wrung mop or cloth.

Failure to do so may cause staining and corrosion of the floor.

If a water leak should occur, always close the shutoff valve.

When the ambient temperature is likely to drop to 0 °C or lower, prevent damage to the pipes and hoses due to freezing.

Frozen water pipes could cause the top unit and the pipes to break, resulting in a water leak.

Regulate the room temperature to prevent the pipes and hoses from freezing during cold months.

When not using the product for a long time, close the shutoff valve, drain the water from the top unit and water supply hose, and then turn the power OFF.*²

When using the product again, allow the product to refill with water first. Otherwise, the water in the tank might become contaminated and cause skin inflammation or other problems. (→Refer to Page 54 for instructions on replenishing the water.)

Leaving the power on may cause fire or heat.

When installing the drain plug with water supply filter, make sure that it is securely tightened in its proper position.

Failure to securely tighten it may cause a water leak.

If the bowl is clogged, turn the power OFF*² and remove the clog.

If the auto flush were allowed to function, it would make the wastewater in the bowl unit overflow and may result in water damage.

Use commercially available tools that are made for unclogging the bowl unit to remove the clogging.

Make sure of the plus and minus signs on the batteries before inserting them.

Remove depleted batteries immediately.

When replacing the batteries:

- Replace both batteries with new ones.
- Use the same brand for both new batteries (any brand available).

Failure to do so may cause the batteries to leak fluid, generate heat, rupture, or ignite.

When the product is supposed not to be used for long time, remove the batteries from the remote control.

Failure to do so may cause the batteries to leak fluid.

This product is classified as Class I Equipment and must be grounded. Install this equipment so that the electrical outlet and power breaker are accessible. Use the new hose set included with this equipment. Do not reuse an old hose set.

*1 If the product has a power plug.

*2 How to turn off the product. (→Page 13)

Operational Precautions

For prevention of malfunctions

Do not block the body sensor or the remote control transmitter or receiver.

About the body sensors

Two types of body sensors are used.

Body sensor A detects changes in heat.

Detection may be difficult when the room temperature exceeds 30 °C, such as in the summertime. When sunlight is directly on the sensor area or a heater is used in the bathroom, the sensor may detect incorrectly due to the heat, resulting in the automatic operation of functions such as auto lid opening and closing.

When the bathroom door is open, the sensor may detect people who pass to the front or side of the toilet.

Body sensor B detects when someone stands in front of the toilet bowl.

Body sensor B emits an infrared beam as shown in the figure. When someone moves into the line of this infrared beam, the sensor detects the person.

Detection by the sensor may be difficult when the toilet is used by someone small, such as a child.

Body sensor A
(Detects changes
in heat)



Body sensor B
(Detects when
someone stands near)



About the seat switch

When you sit on the toilet seat, the seat switch turns ON, enabling you to use various features. (A click sound is heard when the seat switch is ACTIVATED.)

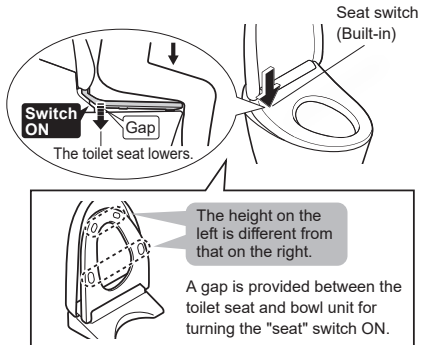

Sit back on the toilet seat.

The seat switch will not turn on unless you sit on the seat properly.



Note: When a child uses the product, the seat switch may not be ACTIVATED by their light body weight. Since the toilet seat is designed to move up and down, a clearance is provided between the toilet seat cushion and the bowl unit.

For prevention of damage

Wipe plastic areas such as the top unit and remote control with a soft cloth tightly wrung out with water.



Do not lean against the toilet lid.



For prevention of malfunctions and failures

Turn the power OFF if there is a risk for lightning strike.*1

A toilet seat cover or a toilet lid cover cannot be used.

The body sensor and seat switch may not function properly. Additionally, the toilet seat and lid may not open or close properly.



Do not urinate on the top unit, toilet seat or wand.

Doing so may cause a failure or discoloration.

Do not apply strong forces to the control panel of the remote control.

When using a toilet cleaner to clean the toilet, rinse it off within 3 minutes and leave the toilet seat and toilet lid open.

If vapor from a toilet cleaner enters the top unit, it may cause a malfunction.

► Wipe off any cleaner that remains on the bowl unit.

Note: If "Auto flush lid closed" (→ Pages 28, 29) is turned ON and you use the remote control to flush the bowl unit, the toilet seat and lid close before flushing the bowl unit.

After the bowl unit has been flushed, open the toilet seat and lid.

Do not use the product with the toilet lid removed.

Do not expose to direct sunlight.

Doing so may cause changes in color, irregular heated seat temperature or remote control malfunction. It may also cause product malfunction due to the change in temperature.

Use radios, etc. away from the product.

The product could cause interference with the radio signal.

If you use a booster seat for infants or a soft highchair, remove it after use.

Keeping it installed may prevent some of the functions from being used.

Do not apply force to the remote control.

This cause malfunction.

► To prevent the remote control from being dropped, set it in the hanger when you are not using it.

Be careful not to expose it to water.

Do not place anything on the toilet seat and lid, and do not press them with hands.

Failure to do so may turn on the seat switch, causing the floor to get wet if buttons on the remote control are touched and warm water comes out from the wand.

This product is intended for use up to a maximum height of 2,000 m above sea level.

*1 How to turn off the product. (→Page 13)

Parts Names

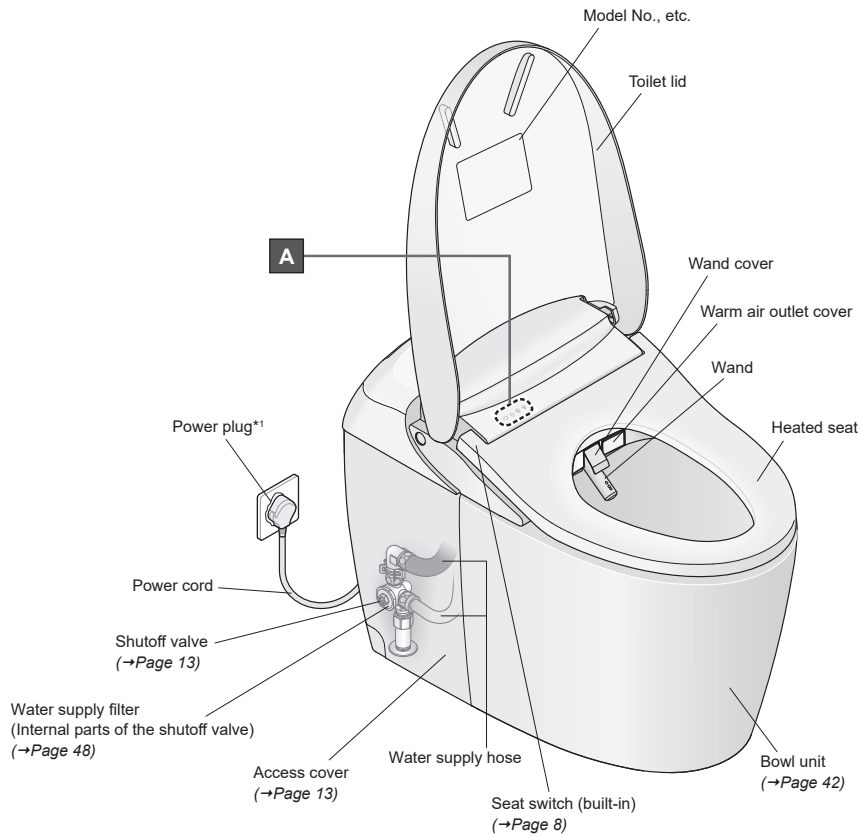

A: Main display

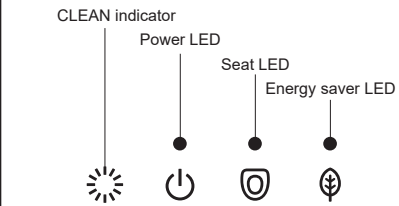

All the CLEAN indicator and LEDs illuminate in the figure

*1 The shape of the power plug may vary.

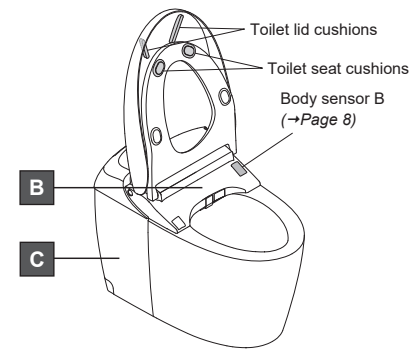

B: Front side of the top unit

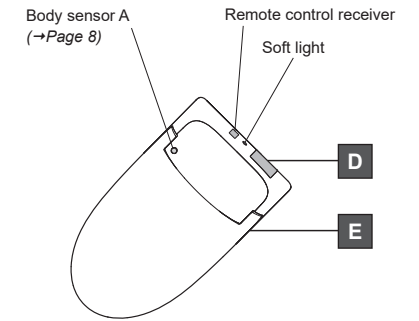
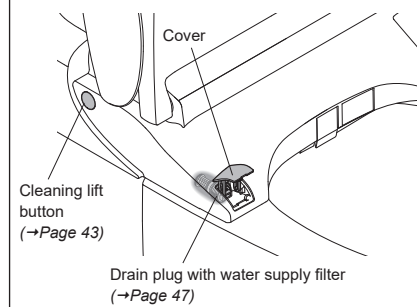

C: Left side of bowl unit

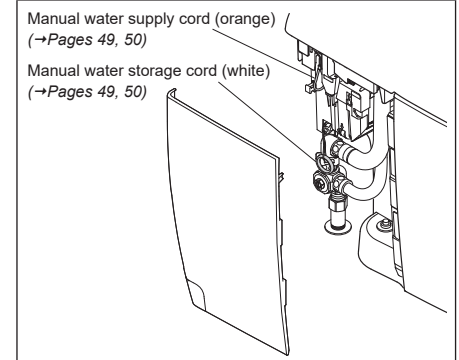

D: Rear side of the top unit

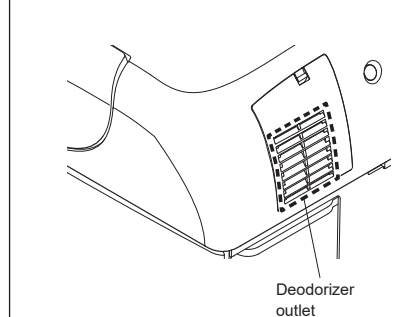

E: Right side of the top unit

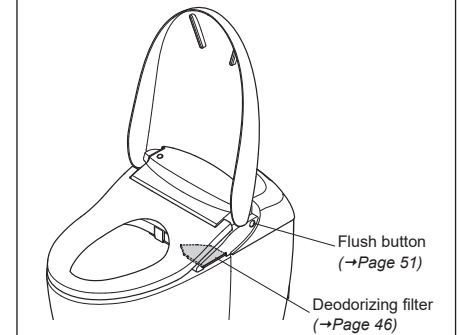

Preparation

Using the Product for the First Time

1. Insert the battery

1.1 Remove the remote control from the hanger.

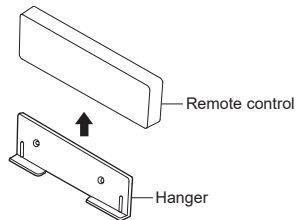

1.2 Open the battery cover and insert two AAA batteries.

After inserting batteries, close the battery cover.

Remote control back side

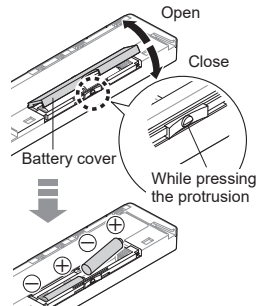

- ▶ When batteries are properly loaded, all the LEDs on the remote control light up for about 2 sec.

1.3 Mount the remote control in the hanger.

About the battery

Use dry cell, alkaline batteries.

Be sure to follow "Safety Precautions" to prevent the batteries from rupturing or leaking fluid. (→Pages 4, 7)

If the remote control is secured to prevent theft

- 1) Remove the hanger hooks (two locations, left and right)

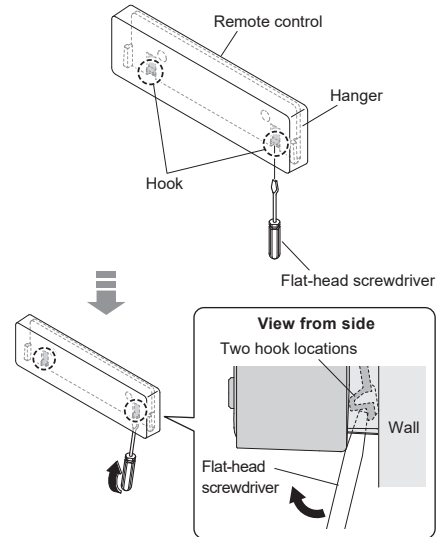

- 2) Remove the remote control from the hanger.

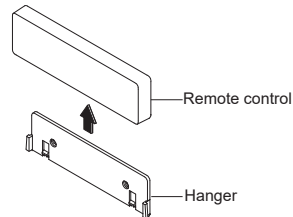

To secure the remote control again

Mount the remote control in the hanger.

2. Turn on the power

2.1 Switch the breaker on the distribution board to ON.

- ▶ The wand extends and then retracts.

2.2 Check the "Power" LED illuminates.

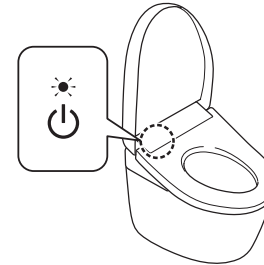

If the light is off

Switch "Power" to "ON" using the remote control.

To operate from the back of remote control

- 1) Press "Power ON/OFF" button about 3 seconds or longer.

To operate from the front of remote control

Recommended if the remote control is secured to prevent theft, etc.

- 1) **■** and **+**
Press and hold both the "Stop" button and "Water pressure adjustment +" button until the remote control LEDs are lit or flashing. (about 10 seconds)
- 2) **+**
Press "Water pressure adjustment +" button.
- 3) **-**
Press "Water pressure adjustment -" button.
- 4) **+**
Press "Water pressure adjustment +" button.

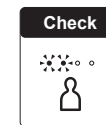

To turn the power "OFF"

Switch the breaker on the distribution board to OFF.

- ▶ The "Power" LED is unilluminated.

3. Open the shutoff valve

3.1 Remove the access cover (left).

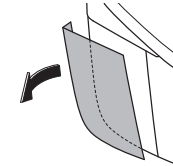

3.2 Fully open the shutoff valve.

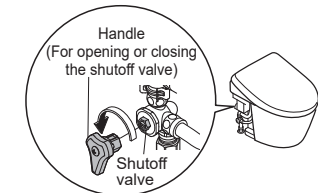

Note: The handle is provided on the back side of the left access cover.

3.3 Attach the left access cover.

- ▶ Attach the left access cover so that there are no gaps between it and the bowl unit top / sides.

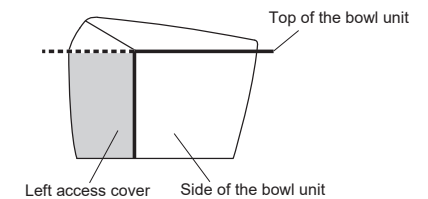

Basic Operations

Mechanism of Auto Functions

"EWATER+" is used automatically to clean the wand and bowl unit.

1. As you approach



Auto open / close

Auto open / close

The toilet lid opens



When the toilet is used in standing position

Open the toilet seat with the remote control.

2. As you sit*1



Deodorizer
Auto bowl CLEAN

Deodorizer

Starts the deodorizer



Removing odors inside the bowl unit.

Note: Deodorizing filter needs regular maintenance. (→Page 46)

Auto bowl CLEAN

Pre-mist



The Bowl light lights up

A mist is automatically sprayed inside the bowl unit to make it more difficult for dirt to adhere.

3. As you stand up



Auto power deodorizer
Auto flushing
Auto wand CLEAN
Auto bowl CLEAN
Auto open / close

Auto power deodorizer

After about 10 seconds

Starts the auto power deodorizer



It stops about 60 seconds after you stand up from the toilet seat

Auto flushing

After about 10 seconds

The toilet flushes*2



Note: The flushing varies depending on how long you sit on the toilet seat.

- Performs a light flush if the time is about 6 to 30 seconds.
- Performs a full flush if the time is about 30 seconds or longer.

Auto wand CLEAN

Only when the washing functions are used.

After about 25 seconds

The wand extends to clean with the "EWATER+" that comes out of the base*3



The Bowl light lights up

Note: "EWATER+" can also be used by pressing the remote control button. (→Page 18 "Wand CLEAN")

Auto bowl CLEAN

After auto wand CLEAN

If the washing functions are not used, after-mist starts after about 25 seconds.

After-mist



The Bowl light lights up

"EWATER+" mist is sprayed on the bowl unit*4

Note: "EWATER+" can also be used by pressing the remote control button. (→Page 42 "Manual Spray")

Auto open / close*5

After about 90 seconds.

The toilet lid closes*2



4. As you move away



Auto flushing
Auto open / close

When the toilet is used in standing position

Auto flushing

About 3 seconds after the user has moved about 30 cm away from the bowl unit

The toilet flushes*2



Performs a light flush.

Auto open / close

About 90 seconds after the user has moved about 30 cm away from the bowl unit

The toilet lid and toilet seat close*2

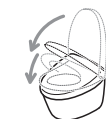

Operation under the default settings is described in "Mechanism of Auto Functions".

These mechanisms be changed. (→Pages 22–39 "Changing Settings")

What is meant by "EWATER+" ?

This water containing hypochlorous acid generated from chloride ions in tap water, is widely used for cleaning and disinfecting items such as food, utensils and baby bottles.

- Well water may not deliver the required effect. (Because the level of chloride ions is low.)
- "EWATER+" helps to minimize dirty surfaces, but does not eliminate the need to clean completely.
- The effect and duration vary depending on the usage environment and conditions.

*1 Water comes out from the area around the wand for several seconds while water is warmed up.

*2 You can change to the setting that closes the toilet lid before flushing the bowl unit. (→Pages 28, 29)

*3 When the washing functions (Rear washing and Front washing etc.) have not been used in 8 hours, the wand is cleaned automatically. (Water comes out from around the wand.)

*4 When the washing feature (Rear washing and Front washing etc.) is not used for about 8 hours, mist is sprayed on the bowl unit automatically.

*5 When you do not sit on the toilet seat, or when you sit on it or stand in front of the bowl unit briefly, it takes about 5 minutes before the lid closes automatically.

Basic Operations

Mechanism of Auto Functions

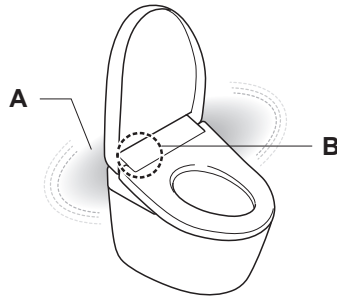

A Soft light

Lighting up the inside of the bathroom with a soft light.

It lights up as you approach the bowl unit and goes off after you move away from the unit and a certain time has passed.

Note: You can turn "Soft light" ON or OFF. (→Page 35)

Night light

You can change "Soft light" and "Bowl light" to "Night mode", a lighting mode suitable for night. (→Page 34)

B CLEAN indicator

Lights to show that the "Auto bowl CLEAN", "Deodorizer", "Auto wand CLEAN", and "Manual spray" functions are operating.

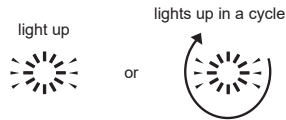

Lights only when the toilet seat is not in-use^{*1}

Note: You can turn "CLEAN indicator" ON or OFF. (→Page 36)

Using the Remote Control

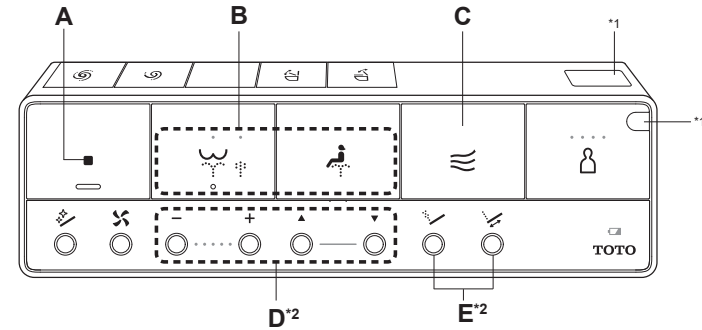

Operate the controls on the remote control; a beep sounds when the top unit receives the signal.

A



Stop

Stops the B or C operation.

B





Rear washing

Washes your rear.



Rear soft washing

Washes your rear with mild water pressure.

The setting changes between  and  each time the  is pressed.



Front washing

Serves as a bidet for ladies.

C



Warm air drying

Dries your rear.

D

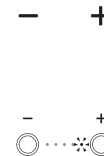



Water pressure adjustment

You can adjust the water pressure to one of five levels. [-] Softer, [+] Stronger

After you press the "Water pressure adjustment" button, the set position will light for 10 seconds.

Wand position adjustment



You can adjust the washing position to 5 different points between the front and the rear, using the [] and [] buttons.

Once use of the remote control is finished, the settings will return to the initial setting (3rd position) after a while, not exceeding a maximum of 5 minutes.

If you do not want to return to 3rd position (→Page 38)

Note: Sitting back on the toilet seat makes it easier to adjust the wand position and to reduce splashing.

E



Pulsating washing

Washes with the water pressure pulsating between soft and strong.



Oscillating washing

The wand moves back and forth to washes your rear thoroughly.

Note: Sitting back on the toilet seat makes it easier to adjust the wand position and to reduce splashing.

*1 Except "Manual spray"

*1 Remote control transmitter

*2 While using B, these buttons and their functions can be operated.

Basic Operations

Using the Remote Control (Continued)

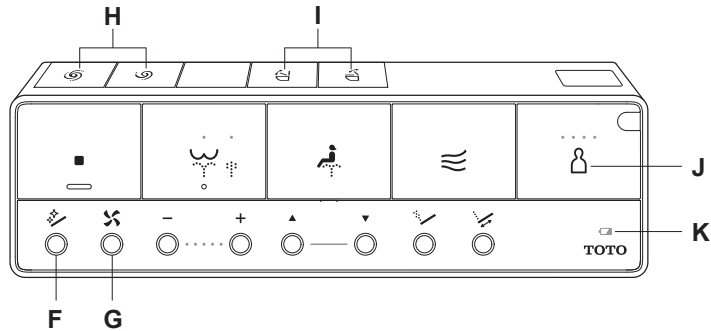

F Wand CLEAN
 Cleans the wand with "EWATER+"*1
 After wand cleaning, water comes out from around the wand.
Note: This function will operate automatically after using the washing functions (Rear washing, Front washing, etc.). (→Pages 14, 32 "Auto wand CLEAN")
Note: To clean the wand with it extended. (→Page 45 "Wand cleaning")

G Power deodorizer
 Press the button to increase suction power and remove odor.
 Cannot be used unless you are seated on the toilet seat.
 Stops automatically in 60 seconds if left running.

H Full flush²
 Performs a full flush.
 Up to 10 m of toilet paper (single)
Light flush²
 Performs a light flush.
 Up to 3 m of toilet paper (single)

I Opening and closing the toilet lid
 Opens and closes the toilet lid.
Opening and closing the toilet seat
 Opens and closes the toilet seat.

J Personal setting
 Up to four people can register their preferred "Water pressure", "Wand position" and "Warm water temperature" settings. (→Pages 38, 39)
To use
 1) Press the button to turn on the LED for the location of your setting.
 ● ○ ○ ○ Register1
 ● ● ○ ○ Register2
 ● ● ● ○ Register3
 ● ● ● ● Register4
 2) Press the wash button you want to use ("Rear washing", etc.)

K Low battery warning mark
 (→Page 51)

Remote control back side
 How to remove the remote control (→Page 12)

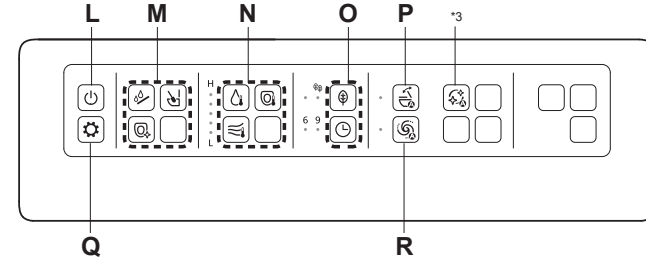

Operate the controls on the remote control; a beep sounds when the top unit receives the signal.

This section is an overview of the settings that can be configured with the remote control. See the corresponding pages for the detailed descriptions.

L "Power ON/OFF" button
 Press and hold for 3 seconds or longer to turn washlet operation on/off.
 ► If the remote control is secured to prevent theft. (→Page 13 2-2.2)

M Wand cleaning (→Page 45)
Bowl unit cleaning
Manual spray
 "EWATER+"*1 mist is sprayed on the bowl unit.
Note: It cannot be used when the wand is out or when you are sitting on the toilet seat.

N Warm water temperature
Toilet seat temperature
Drying air temperature
 Adjust temperatures (→Pages 20, 21)

O Auto energy saver / Auto energy saver+
Timer energy saver
 Saving energy (→Pages 26, 27)

P Auto open/close ON / OFF
 Changing Settings (→Page 30)

Q Setting confirmation
 The current setting can be discerned from the LEDs.

R Auto flushing ON / OFF
 Changing Settings (→Page 27)

*1 What is meant by "EWATER+" ? (→Page 15)

*2 You can change to the setting that closes the toilet lid before flushing the bowl unit. (→Pages 28, 29)

*3 The button is not used with this product, so pressing it does not perform operations.

Temperature Adjustment

Warm Water, Toilet Seat, Drying

Five different temperature levels from high to low and "OFF" can be set.

Remote control back side

How to remove the remote control (→Page 12)

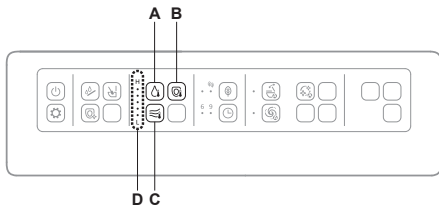

- A Warm water temperature button**
(When you want to adjust the warm water temperature)
- B Toilet seat temperature button**
(When you want to adjust the toilet seat temperature)
- C Drying air temperature button**
(When you want to adjust the drying air temperature)
- D Displaying the temperature level of the pressed button**

Adjusting the temperature

- 1.** Remove the remote control from the hanger.
 - ▶ If the remote control is secured to prevent theft. (→Page 12)
- 2.** Choose and press the button of the temperature that you want to set from the ("Toilet seat temperature" button), ("Warm water temperature" button) and (Drying air temperature button).
 - ▶ The current temperature level appears.

If adjusting the temperature does not warm up the toilet seat.
▶ Is the energy saver set to "ON"? (→Pages 24, 25)

- 3.** Press the button selected in step 2 repeatedly until a desired temperature level illuminates.

▶ The setting changes each time the button is pressed once

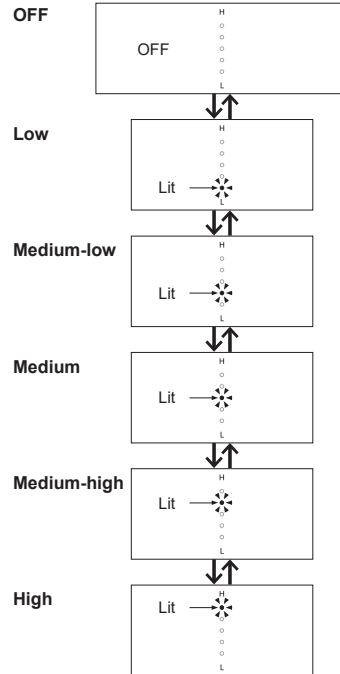

Settings complete

▶ When seat temperature is set, the SEAT LED illuminates.



Note: The "Drying" cannot be turned "OFF".
If the button is not pressed for about 10 seconds, the "Temperature adjustment" LED will go off, but the setting will be retained.
If the "Temperature adjustment" LED goes out before the setting is completed, start all over again at step 2.

- 4.** Mount the remote control in the hanger.

▶ If the remote control is secured to prevent theft. (→Page 12)

To turn the warm water temperature*1 and toilet seat temperature "OFF"

- 1.** Remove the remote control from the hanger.
 - ▶ If the remote control is secured to prevent theft. (→Page 12)
- 2.** Select a temperature button you want to turn "OFF" from ("Toilet seat temperature" button), ("Warm water temperature" button) and press it.
 - ▶ The current temperature level appears.

*1 To prevent condensation, the water temperature does not drop below 20 °C even when set to "OFF".

- 3.** Press the button selected in step 2 repeatedly until the temperature level is set to "OFF".

▶ The setting changes each time the button is pressed once

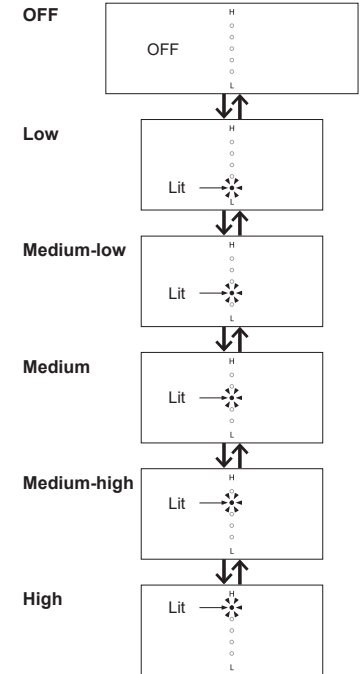

Settings complete

▶ When seat temperature is OFF, the SEAT LED is unilluminated.



Note: The "Drying" cannot be turned "OFF".

- 4.** Mount the remote control in the hanger.

▶ If the remote control is secured to prevent theft. (→Page 12)

Changing Settings

Setting List

Setting Types	Available Settings Bold: Initial settings
Auto energy saver (→Page 26)	ON/OFF
Auto energy saver+ (→Page 26)	ON/OFF
Timer energy saver (→Page 27)	6H/9H/OFF
Auto flushing (→Page 27)	ON/OFF
Auto flush delay (→Page 28)	SET1/SET2/SET3
Auto flush lid closed (→Page 28)	ON/OFF
Auto open / close (→Page 30)	ON/OFF
Auto close delay (→Page 30)	SET1/SET2
Auto open delay (→Page 31)	SET1/SET2/SET3
Seat/lid (→Page 31)	Lid/Seat-Lid
Auto wand CLEAN (→Page 32)	ON/OFF
Auto bowl CLEAN (→Page 32)	ON/OFF
Deodorizer (→Page 33)	ON/OFF
Auto power deodorizer (→Page 33)	ON/OFF
Night light (→Page 34)	ON/STANDBY/TIMER
Soft light (→Page 35)	ON/OFF
Bowl light (→Page 35)	ON/OFF
CLEAN indicator (→Page 36)	ON/OFF
Anti freezing (→Page 36)	ON/OFF
Beep sound (→Page 37)	ON/OFF*1
Lower water level (→Page 37)	-
Pressure/position setting (→Page 38)	ON/OFF
Personal setting (→Page 38)	ON/OFF
Registering Personal Settings (→Page 39)	Register 1/Register 2/Register 3/Register 4

Setting with buttons on the front of the remote control.

Press the button indicated in step 1 for approximately 10 seconds or longer to enter setting mode.

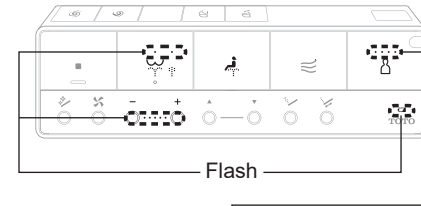

Check

■ Press "Stop" button about 10 seconds or longer.

■ and + Press "Stop" button and "Water pressure adjustment +" button about 10 seconds or longer.

Note: During setting, if the next button is not pressed within about 60 seconds, the light will stop flashing. If you fail to complete the setting, redo from the step 1.

Setting with buttons on the back of the remote control.

Remote control back side
How to remove the remote control (→Page 12)

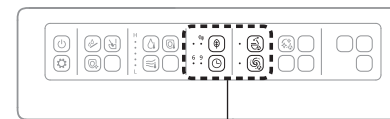

Use the LED to check settings.

▶ Setting buttons (→Pages 22–39)

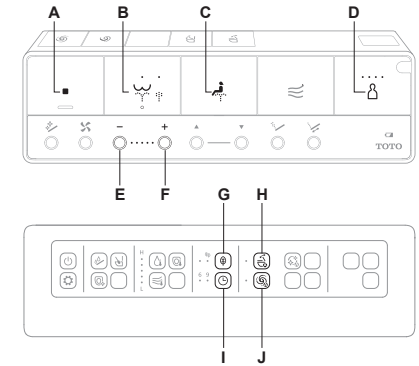

- A Stop button
- B Rear washing button
- C Front washing button
- D Personal setting button
- E Water pressure adjustment - button
- F Water pressure adjustment + button
- G Auto energy saver button
- H Auto open / close button
- I Timer energy saver button
- J Auto flushing button

*1 The beep sounds when settings are being changed, even if the beep noise is turned off. (except for "Lower water level", "Pressure/position setting" or "Personal setting".)

Changing Settings

The energy saver features

"Auto energy saver", "Auto energy saver+" or "Timer energy saver" can be selected.

To save energy, the temperature of the toilet seat becomes low (or "OFF").

Note: Even if the energy saver is activated (with the toilet seat heater set to Low or OFF), the toilet seat will be temporarily heated when you sit on it. (To reach the set temperature, the toilet seat takes about 15 minutes.)

The LED indication on the main display returns to the state for when the energy saver is on.

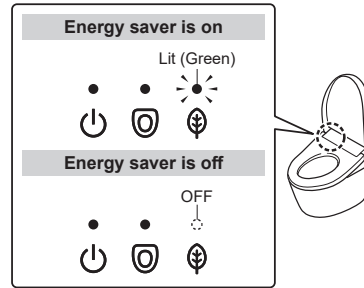

Auto energy saver

You want the product to save energy automatically

The product detects time periods with infrequent use and lowers the toilet seat temperature automatically. It takes about 10 days for the product to determine the periods when it is used relatively less frequently.

When energy saver is in operation

Main display

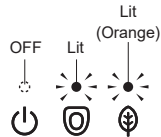

Toilet seat heater



Example

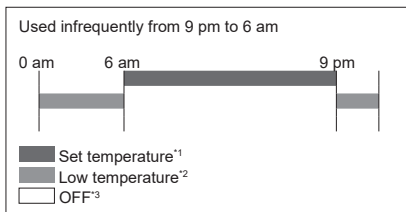

Auto energy saver+

You want to save more energy

In addition to the "Auto energy saver" feature, it automatically turns off the toilet seat heater during time periods when the toilet is not used.

When energy saver is in operation

Main display

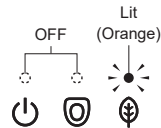

Toilet seat heater

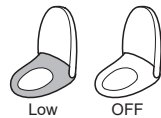

Example

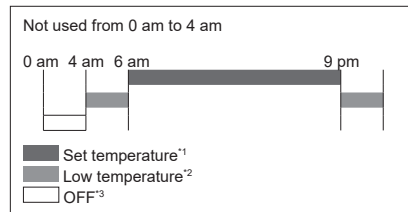

Timer energy saver

You want to save energy only for a preset duration of time. (6 hours, 9 hours)

Once the time is set, the toilet seat heater turns off automatically during the set time period every day.

When energy saver is in operation

Main display

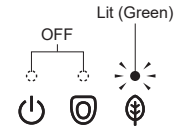

Toilet seat heater



Example

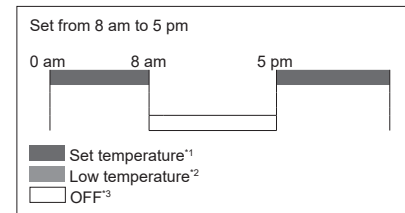

Timer energy saver and Auto energy saver / Auto energy saver+

You want to save the maximum amount of energy possible?

When both "Timer energy saver" and "Auto energy saver / Auto energy saver+" are set, "Auto energy saver / Auto energy saver+" operates when "Timer energy saver" is not operating.

When energy saver is in operation

Main display

During "Auto energy saver / Auto energy saver+":

- ▶ Same LED indication as "Auto energy saver / Auto energy saver+" (→Page 24)

During "Timer energy saver":

- ▶ Same LED indication as "Timer energy saver" (→See the description on the left)

Toilet seat heater

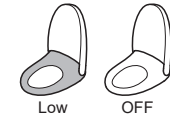

Example

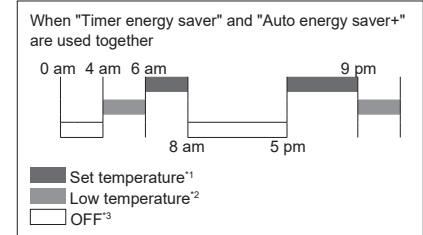

*1 The toilet seat temperature settings on pages 20, 21.
 *2 The time period when the toilet seat heater is set to a "Low".
 *3 The time period when the toilet seat heater is set to a "OFF".

Changing Settings

How to Set

Auto energy saver

- 

Press "Auto energy saver" button.

► The setting changes each time the button is pressed once.

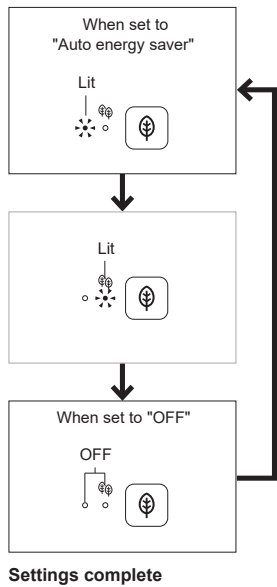

Auto energy saver+

- 

Press "Auto energy saver+" button.

► The setting changes each time the button is pressed once.

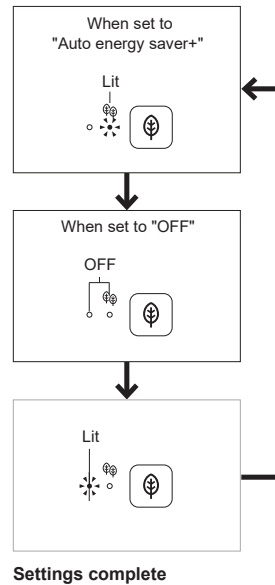

Timer energy saver

Set the "Timer energy saver" at the time you want to start it.
Example: To save energy from 1 am to 7 am (for 6 hours)

- 

When the time of the day reaches 1:00 am at night, press "Timer energy saver" button.

Press the "Timer energy saver" button repeatedly until the "6" LED illuminates.

► The setting changes each time the button is pressed once.

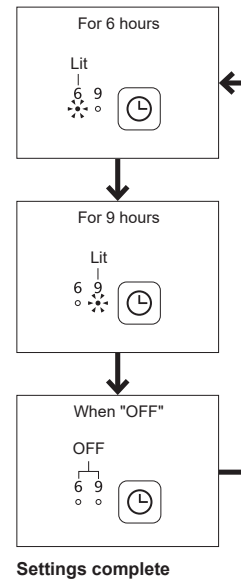

Auto flushing

Set whether or not to clean the bowl unit automatically

- 

Press "Auto flushing" button.

► The setting changes each time the button is pressed once.

Set whether or not to clean the bowl unit automatically.

Check the "Auto flushing" LED (→Page 23)

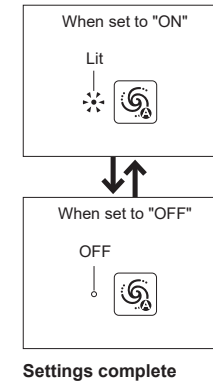



Changing Settings

Auto flush delay*1

Change the amount of time before the toilet flushes automatically

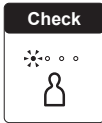
-  Press "Stop" button until all LEDs on the remote control are lit or flashing. (about 10 seconds)



-  Press "Rear washing" button.

-  Press "Front washing" button.

- Choose and press the button of the item that you want to set.

Change the amount of time before the toilet flushes automatically.

When set to "SET1"	When set to "SET2"	When set to "SET3"
Press "Water pressure adjustment -" button.	Press "Rear washing" button.	Press "Water pressure adjustment +" button.
-		+
Short beeps	Long beep	Short beep

- SET 1 (Short) : After about 5 seconds
- SET 2 (Standard) : After about 10 seconds
- SET 3 (Long) : After about 15 seconds

Note: If "Auto flush lid closed" is turned ON, the toilet lid closes before flushing the bowl unit as above.

Settings complete

Auto flush lid closed

Set whether or not to close the toilet lid automatically before flushing the bowl unit

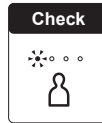

-  Press "Stop" button until all LEDs on the remote control are lit or flashing. (about 10 seconds)



-  Press "Rear washing" button.

-  Press "Water pressure adjustment +" button.

- Choose and press the button of the item that you want to set.

When set to "ON"	When set to "OFF"
Press "Rear washing" button.	Press "Front washing" button.
	
Short beep	Long beep

Settings complete

About "Auto flush lid closed"...

About 10 seconds after you stand up or move away from the bowl unit if you use the toilet in standing position, the toilet lid closes automatically before flushing the bowl unit.

Also, if you press the Flush buttons ("Full flush" or "Light flush") on the remote control, the toilet lid closes before flushing the bowl unit.

Using the toilet seat



Stand up

The toilet lid closes in about 10 seconds.

- ▶ The toilet lid closes before flushing the bowl unit.

Using the toilet in standing position



Move away

The toilet lid and toilet seat close
About 10 seconds after the user has moved about 30 cm away

- ▶ The toilet seat and lid close before flushing the bowl unit.

Using the flush buttons on the remote control



Press

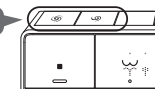

The toilet lid closes.

- ▶ The toilet lid closes before flushing the bowl unit.

"Auto flush lid closed" does not work if "Auto flushing" and "Auto open / close" are set as below: (Except when using the Flush buttons on the remote control)

	Auto flushing	Auto open / close
1)	OFF	ON
2)	ON	OFF
3)	OFF	OFF

- The toilet lid closes automatically but the bowl unit does not flush.
- The bowl unit flushes automatically but the toilet lid does not close.
- The toilet lid does not open / close and the bowl unit does not flush automatically.

Turn both "Auto flushing" and "Auto open / close" ON. (→Pages 27, 30)

Even if "Auto flushing" is turned ON, "Auto flush lid closed" may not work in some cases. For details, refer to "Auto flush lid closed" does not work in "Troubleshooting". (→Page 63)

Note: You can change the length of time before water flushes after closing the toilet lid automatically to [SET 1], [SET 2], or [SET 3]. (→Page 28)

If you get up slightly from the seat or sit forward on the seat while seated on it, the seat switch may not detect properly, which results in the toilet lid being closed and bowl unit being flushed.

Sit back on the toilet seat. (→Page 8)

While using the toilet in standing position, the toilet lid may close and the bowl unit may be flushed. Stand straight in front of the bowl unit.

*1 The length of time specified for "Auto close delay (Auto flush lid closed)" if "Auto flush lid closed" is turned ON.

Changing Settings

Auto open / close

Set whether or not to open and close the toilet lid automatically



Press "Auto open / close" button.

- ▶ The setting changes each time the button is pressed once.

Set whether or not to open and close the toilet lid automatically.

Check the "Auto open/close" LED (→Page 23)

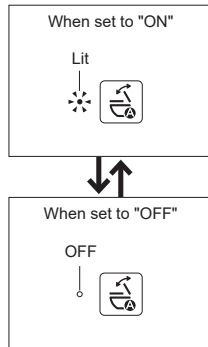

Settings complete

Auto close delay*1

Change the amount of time before the lid/seat closes automatically



Press "Stop" button until all LEDs on the remote control are lit or flashing. (about 10 seconds)

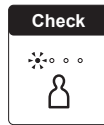

Press "Front washing" button.



Press "Rear washing" button.

4. Choose and press the button of the item that you want to set.

Change the amount of time before the lid/seat closes automatically.

When set to "SET1" ² Press "Water pressure adjustment -" button. - Short beep	When set to "SET2" Press "Water pressure adjustment +" button. + Long beep
---	---

SET 1 (Short) : After about 25 seconds
SET 2 (Standard) : After about 90 seconds

Settings complete

Auto open delay

Change the time period till automatic opening (After closing by hand or remote control.)



Press "Stop" button until all LEDs on the remote control are lit or flashing. (about 10 seconds)

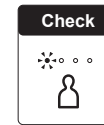

Press "Front washing" button.



Press "Water pressure adjustment +" button.

4. Choose and press the button of the item that you want to set.

Change the time period till automatic opening.

When set to "SET1" Press "Rear washing" button. Long beep	When set to "SET2" Press "Front washing" button. Short beep	When set to "SET3" Press "Water pressure adjustment -" button. - Short beeps
---	---	---

SET 1 (Standard) : After about 15 seconds
SET 2 (Middle) : After about 30 seconds
SET 3 (Long) : After about 90 seconds

Settings complete

Seat/lid

Automatically open and close the toilet lid/
Automatically open and close the toilet seat and toilet lid



Press "Stop" button until all LEDs on the remote control are lit or flashing. (about 10 seconds)

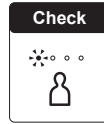

Press "Front washing" button.



Press "Water pressure adjustment -" button

4. Choose and press the button of the item that you want to set.

**Automatically open and close the toilet lid/
Automatically open and close the toilet seat and toilet lid.**

When set to "Lid" Press "Rear washing" button. Long beep	When set to "Seat · lid" Press "Front washing" button. Short beep
--	---

Settings complete

*1 If "Auto flush lid closed" is turned ON, you cannot use this setting to change the length of time before closing the toilet lid automatically. Configure the settings for "Auto flush delay". (→Page 28)

*2 When set to "SET 1", the lid/seat does not open automatically for about 15 seconds after closing automatically.

Changing Settings

Auto wand CLEAN

Set whether or not to clean the wand automatically

- 

Press "Stop" button until all LEDs on the remote control are lit or flashing. (about 10 seconds)

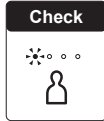

- +

Press "Water pressure adjustment +" button.

- 

Press "Rear washing" button.

- Choose and press the button of the item that you want to set.

Set whether or not to clean the wand automatically.

When set to "ON" Press "Water pressure adjustment +" button. + Short beep	When set to "OFF" Press "Water pressure adjustment -" button. - Long beep
--	--

Settings complete

Auto bowl CLEAN

Set whether or not to spray mist in the bowl unit automatically

- 

Press "Stop" button until all LEDs on the remote control are lit or flashing. (about 10 seconds)

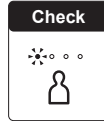

- +

Press "Water pressure adjustment +" button.

- 

Press "Front washing" button.

- Choose and press the button of the item that you want to set.

Set whether or not to spray mist in the bowl unit automatically.

When set to "Spray" Press "Water pressure adjustment +" button. + Short beep	When set to "do not spray" Press "Water pressure adjustment -" button. - Long beep
---	---

Settings complete

Deodorizer

Set whether or not to deodorize automatically after sitting on the toilet seat

- 

Press "Stop" button until all LEDs on the remote control are lit or flashing. (about 10 seconds)

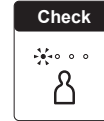

- Press "Water pressure adjustment -" button.

- 

Press "Front washing" button.

- Choose and press the button of the item that you want to set.

Set whether or not to deodorize automatically after sitting on the toilet seat.

When set to "ON" Press "Water pressure adjustment +" button. + Short beep	When set to "OFF" Press "Water pressure adjustment -" button. - Long beep
--	--

Settings complete

Auto power deodorizer

Set whether or not to power deodorize automatically after standing up

- 

Press "Stop" button until all LEDs on the remote control are lit or flashing. (about 10 seconds)

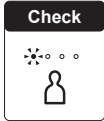



- Press "Water pressure adjustment -" button.

- +

Press "Water pressure adjustment +" button.

- Choose and press the button of the item that you want to set.

Set whether or not to power deodorize automatically after standing up

When set to "ON" Press "Rear washing" button.  Short beep	When set to "OFF" Press "Front washing" button.  Long beep
--	---

Settings complete

Changing Settings

Night light

Set whether or not to change "Soft light" and "Bowl light" to "Night mode", a lighting mode suitable for night, as well as the time window.

To set the time window (timer), set the desired start time.

1. ■ and +

Press and hold both the "Stop" button and "Water pressure adjustment +" button until the remote control LEDs are lit or flashing. (about 10 seconds)

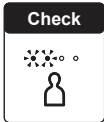

2.

Press "Rear washing" button.

3. +

Press "Water pressure adjustment +" button.

4. Choose and press the button of the item that you want to set.

When set to "ON" ON Press "Rear washing" button. Short beep	When set to "OFF" STANDBY Press "Front washing" button. Long beep	When set to "the time window" TIMER Press "Water pressure adjustment -" button. - Short beep
--	--	--

Settings complete

About "Night light"...

You can change "Soft light" and "Bowl light" to "Night mode", a lighting mode suitable for night.

Note: The light does not turn on if "Soft light" and "Bowl light" are turned OFF.

The "Night light" is turned ON

Soft light

Lights permanently



Bowl light

Lights up only while someone is detected

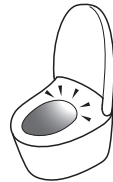

The brightness changes according to human movement.

The "Night light" is turned OFF [STANDBY]

Soft light

Lights up as specified in the settings



Bowl light

Lights up as specified in the settings

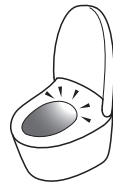

The "Night light" is configured with the timer



The light turns ON / OFF [STANDBY] every 12 hours starting from the set time.

Example

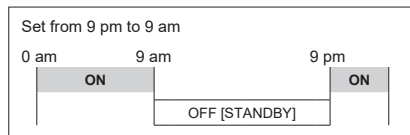

Soft light

Set whether or not to use the soft light

1. ■ and +

Press and hold both the "Stop" button and "Water pressure adjustment +" button until the remote control LEDs are lit or flashing. (about 10 seconds)

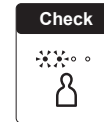

2.

Press "Rear washing" button.

3.

Press "Front washing" button.

4. Choose and press the button of the item that you want to set.

Set whether or not to use the soft light.

When set to "ON" Press "Water pressure adjustment +" button. + Short beep	When set to "OFF" Press "Water pressure adjustment -" button. - Long beep
--	--

Settings complete

Bowl light

Set whether or not to use the light inside the bowl unit

1. ■ and +

Press and hold both the "Stop" button and "Water pressure adjustment +" button until the remote control LEDs are lit or flashing. (about 10 seconds)

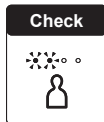

2.

Press "Rear washing" button.

3. +

Press "Water pressure adjustment +" button.

4. Choose and press the button of the item that you want to set.

Set whether or not to use the light inside the bowl unit.

When set to "ON" Press "Rear washing" button. Short beep	When set to "OFF" Press "Front washing" button. Long beep
--	---

Settings complete

Changing Settings

CLEAN indicator

Set whether or not to light up the CLEAN indicator

1. ■ and +

Press and hold both the "Stop" button and "Water pressure adjustment +" button until the remote control LEDs are lit or flashing. (about 10 seconds)

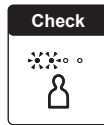

- 2.

Press "Rear washing" button.

3. -

Press "Water pressure adjustment -" button.

4. Choose and press the button of the item that you want to set.

Set whether or not to light up the CLEAN indicator

<p>When set to "ON"</p> <p>Press "Rear washing" button.</p> <p>Short beep</p>	<p>When set to "OFF"</p> <p>Press "Front washing" button.</p> <p>Long beep</p>
---	--

Settings complete

Anti freezing

Set whether or not to run the water for the bowl unit and top unit automatically at a fixed interval in order to prevent freezing

1. ■ and +

Press and hold both the "Stop" button and "Water pressure adjustment +" button until the remote control LEDs are lit or flashing. (about 10 seconds)

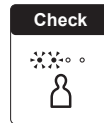

2. -

Press "Water pressure adjustment -" button.

- 3.

Press "Front washing" button.

4. Choose and press the button of the item that you want to set.

<For setting to [ON]>
When the time is set, the bowl unit is cleaned in about 10 minutes intervals to prevent freezing.

<p>When set to "ON"</p> <p>Press "Water pressure adjustment +" button.</p> <p>+</p> <p>Short beep</p>	<p>When set to "OFF"</p> <p>Press "Water pressure adjustment -" button.</p> <p>-</p> <p>Long beep</p>
---	---

Settings complete

Beep sound

Set whether or not to make a beep sound

1. ■ and +

Press and hold both the "Stop" button and "Water pressure adjustment +" button until the remote control LEDs are lit or flashing. (about 10 seconds)

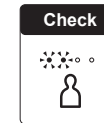

2. -

Press "Water pressure adjustment -" button.

- 3.

Press "Rear washing" button.

4. Choose and press the button of the item that you want to set.

Set whether or not to make a beep sound.

<p>When set to "ON"</p> <p>Press "Water pressure adjustment +" button.</p> <p>+</p> <p>Short beep</p>	<p>When set to "OFF"</p> <p>Press "Water pressure adjustment -" button.</p> <p>-</p> <p>Long beep</p>
---	---

Settings complete

Lower water level

Lower the bowl unit water level (For reducing water rebound, collecting a stool sample, etc.)

1. ■ and +

Press and hold both the "Stop" button and "Water pressure adjustment +" button until the remote control LEDs are lit or flashing. (about 10 seconds)

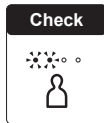

2. -

Press "Water pressure adjustment -" button.

- 3.

Press "Rear washing" button.

- 4.

Press "Front washing" button.

▶ Short beep

▶ The water in the bowl unit flows and accumulates at a low water level.

Settings complete

Note: The water level returns normal when the toilet is flushed.
Please set this function each time you want to lower the water level.

Changing Settings

Pressure / position setting

Set whether or not to keep your favorite pressure and position settings

1. ■ and +

Press and hold both the "Stop" button and "Water pressure adjustment +" button until the remote control LEDs are lit or flashing. (about 10 seconds)

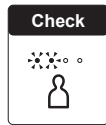

2. 🚿

Press "Rear washing" button.

3. +

Press "Water pressure adjustment +" button.

4. -

Press "Water pressure adjustment -" button
▶ The current setting is displayed.

5. -

Press "Water pressure adjustment -" button
▶ The setting changes each time the button is pressed once.

Pressure/Position setting

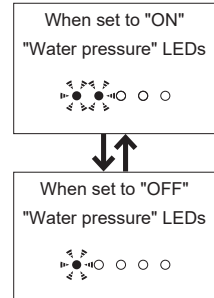

6. ■

Press "Stop" button.
Settings complete

Personal setting

Set whether or not to use the personal setting

1. ■ and +

Press and hold both the "Stop" button and "Water pressure adjustment +" button until the remote control LEDs are lit or flashing. (about 10 seconds)

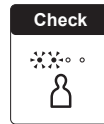

2. -

Press "Water pressure adjustment -" button.

3. +

Press "Water pressure adjustment +" button.

4. 🚿

Press "Front washing" button.
▶ The current setting is displayed.

5. -

Press "Water pressure adjustment -" button
▶ The setting changes each time the button is pressed once.

Pressure/Position setting

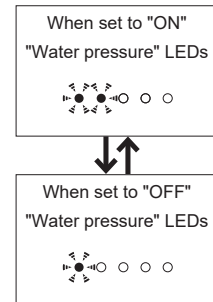

6. ■

Press "Stop" button.
Settings complete

Registering Personal Settings*1

Register your preferred wand position, etc.

1. 🚿

Press "Personal setting" button.

Select the location to be set

▶ The setting changes each time the button is pressed once.

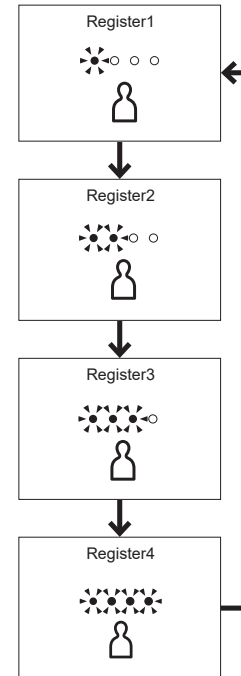

2. Set your preferences for "Wand position", "Water pressure" and "Warm water temperature" during "Rear washing", etc.

3. 🚿

Press "Personal setting" button about 5 seconds or longer. (Short beep)

Settings complete

*1 Cannot be performed when "Personal setting" is set to "OFF".

Maintenance

Before Maintenance

⚠ WARNING

Always turn off the power before maintenance or inspection.

Failure to do so may cause electric shock or malfunction, resulting in a breakdown.

For safety, turn the power OFF before maintenance.*1*2

When the power is turned OFF, the Power LED is unilluminated.

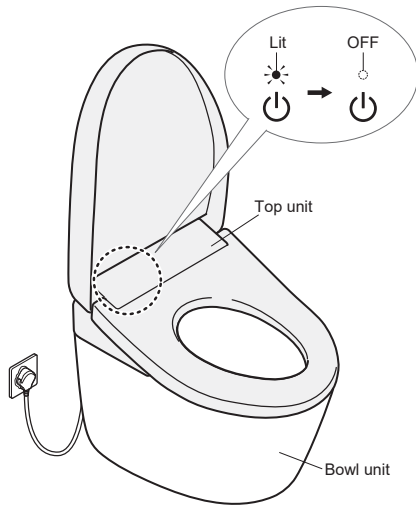

To turn the power "OFF"

Switch the breaker on the distribution board to OFF.

To turn the power "ON"

Switch the breaker on the distribution board to ON.

▶ The "Power" LED illuminates.

Top Unit



- Soft cloth soaked in water

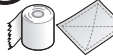

- Toilet paper
- Dry cloth
- Nylon scrubbing brush

May cause damage.

Approximately daily

1. Turn the power "OFF". (→Page 40)

2. Wipe with a soft cloth that has been soaked in water and wrung out thoroughly.

For heavy dirt

Wipe with a soft cloth soaked in diluted, pH neutral kitchen detergent, and then wipe with a soft cloth soaked in water.



- pH neutral kitchen detergent
- Paint thinner
- Benzene
- Powdered cleanser

3. Turn the power "ON". (→Page 40)

▶ The "Power" LED illuminates.

Attention

This product is an electric appliance. Be careful not to let water seep inside or leave detergent in the gap between the top unit and bowl unit.

Do not put any cleaning solution directly onto the warm air outlet or cover around the wand, etc.

May damage plastic parts or cause a malfunction.

When using a toilet cleaner to clean the toilet, rinse it off within 3 minutes and leave the toilet seat and toilet lid open.

Wipe off any cleaner that remains on the bowl unit.

If vapor from a toilet cleaner enters the top unit, it may cause a malfunction.

<If "Auto flush lid closed" (→Pages 28, 29) is turned ON> (→Page 9)

Do not press or pull the warm air outlet or cover around the wand with excessive force.

Doing so may cause damage or failure.

Wipe the back surface of the toilet seat and the toilet seat cushions with a soft cloth tightly wrung out with water.

Otherwise adhesion of dirt may result in discoloration.

*1 Except when using "Wand cleaning", "Bowl unit cleaning" and "Manual spray"

*2 The toilet lid does not open automatically for about 10 to 60 seconds after the power is turned ON (preparing).

Operate with the remote control.

Maintenance

Bowl Unit



- Cleaning sponge
- Brush
- Neutral toilet detergent



- Strongly acidic cleaners or strong alkaline cleaners
- Cleaners containing abrasive compounds
- Fluoride-based detergent (containing hydrogen fluoride or ammonium fluoride)
- Water-repelling cleaner
- Wire brush
- Abrasive nylon scrubbing brush

Approximately daily

1. Turn the power "OFF". (→Page 40)

2. Clean with a cleaning sponge or brush.

The water level in the bowl unit can be lowered to perform maintenance. Turn the power ON. (→Page 40)

<Bowl unit cleaning>

Remote control back side

How to remove the remote control (→Page 12)



Press "Bowl unit cleaning" button.

The water in the bowl unit flows, and then drains. After that, the water level drops for about 50 seconds. Clean inside the bowl unit.

- The water in the bowl unit drains, and then returns to its original level.
- To stop part way through.

Press "Stop" button on the front side of the remote control.

If the bowl unit is clogged

Using plunger or similar, provide 10 cm or more clearance between the top of the bowl unit and the water surface. Use commercially available tools that are made for unclogging the bowl unit.
(May cause overflow of dirty water and water damage.)

If the floor is dirty

Clean it with a well wrung cloth. Otherwise, stains or corrosion may occur on the floor.

Note: *Sitting is recommended to reduce splashing caused by standing and urinating.*

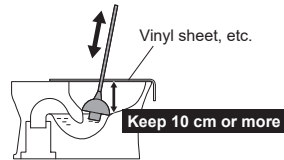

3. Turn the power "ON". (→Page 40)

- ▶ The "Power" LED illuminates.

Attention

Be careful not to expose the top unit or the gap between it and the bowl unit to water.

Otherwise, water may overflow into the room.

Do not use any water repellent, stain-proofing cleaner or surface coating agent. These products would not damage the porcelain surface, but they may cover the porcelain surface and reduce the effect of the built-in stain prevention technology.

Manual Spray

EWATER+ mist can be sprayed to separate dirt from the surface for maintenance.

Approximately daily

<Manual spray>

Remote control back side

How to remove the remote control (→Page 12)



Press "Manual spray" button.

- ▶ EWATER+ mist is sprayed on the bowl unit.

Note: *It cannot be used when the wand is out or when you are sitting on the toilet seat.*

To perform maintenance with a brush, etc. (→Page 42 "Bowl unit cleaning")

Gap between the Top Unit and Bowl Unit

You can lift up the top unit with the cleaning lift button and clean the gap between it and the bowl unit.



- Soft cloth soaked in water

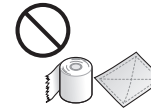

- Toilet paper
 - Dry cloth
 - Nylon scrubbing brush
- May cause damage.

Approximately once a month

1. Turn the power "OFF". (→Page 40)

2. Open the toilet seat and lid.

3. Press the cleaning lift button.

- ▶ This raises the front side of the top unit.

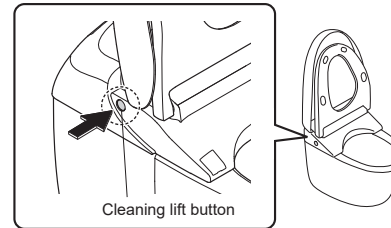

4. Clean the gap.

- ▶ Wipe with a soft cloth soaked in a diluted, neutral kitchen detergent. Then, wipe it with a soft cloth soaked in water so that no detergent remains.

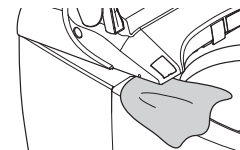

CAUTION

Do not use the product while the top unit is lifted up by the cleaning lift.

When lowering the top unit by the cleaning lift, do not insert your fingers into the gap between the top unit and the bowl unit.

Attention

Do not directly spray cleaner and water.

Do not force the toilet seat or lid to move while the top unit is raised up.

5. Close the toilet seat.



6. Push the top unit down firmly until a click sound is no longer heard.



Make sure to push these locations



Push it straight down

*Up to 6 clicks can be heard.

7. Turn the power "ON". (→Page 40)

- ▶ The "Power" LED illuminates.

Maintenance

Gap between the Top Unit and the Toilet Lid

The toilet lid can be removed for thorough cleaning.

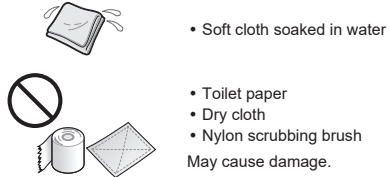

Approximately once a month

1. Turn the power "OFF" (→Page 40)

2. Remove the toilet lid.

Slightly tilt the toilet lid to the front.

- A Pull left side outward.
- B Disconnect the hinge from the tab and pull up.
- C Remove the toilet lid.

Hold with both hands

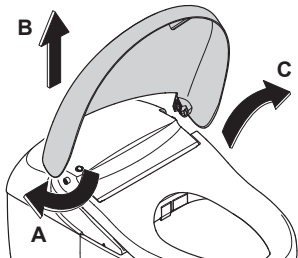

3. Wipe with a soft cloth that has been soaked in water and wrung-out thoroughly.

4. Reinstall the toilet lid.

- D Align the right side pin and hinge parts. Slightly tilt the toilet lid to the front.
- E While pulling left side outward.
- F Mount by joining the hinge with the tab.

Attention

Be careful not to pinch your fingers.

Hold with both hands

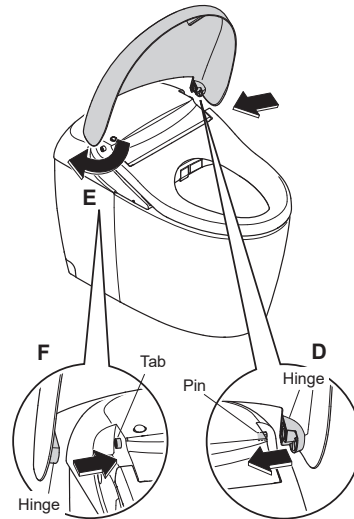

5. Turn the power "ON". (→Page 40)

▶ The "Power" LED illuminates.

6. Open and close the toilet lid to check the reinstallation.

Wand

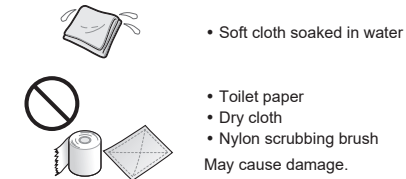

Approximately once a month If you notice dirt (Wand cleaning)

1. Extend the wand.

To operate from the back of remote control

Remote control back side
How to remove the remote control (→Page 12)



1) Press "Wand cleaning" button.

To operate from the front of remote control

Recommended if the remote control is secured to prevent theft, etc.

1) ■ and +

Press and hold both the "Stop" button and "Water pressure adjustment +" button until the remote control LEDs are lit or flashing. (about 10 seconds)

Check



2) +
Press "Water pressure adjustment +" button.

3)
Press "Front washing" button.

4)
Press "Rear washing" button.

- ▶ The wand extends and water sprays out for cleaning.
- ▶ The wand automatically retracts after about 5 minutes.

2. Wipe with a soft cloth that has been soaked in water and wrung out thoroughly.

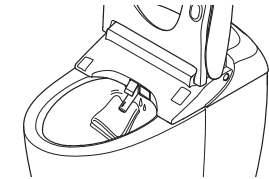

Attention

Do not pull, push or press the wand with excessive force.
May cause damage or malfunction.

3. ■
Press "Stop" button.

▶ The wand retracts.

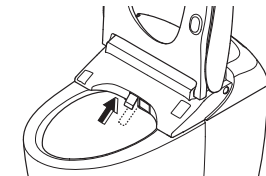

Maintenance

Deodorizing Filter

Approximately once a month

1. Turn the power "OFF". (→Page 40)
2. Remove the deodorizing filter.
Hold the tab and pull outward.

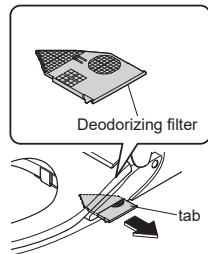

Attention

Do not pull the unit with undue force.
Doing so may cause damage or malfunction.

3. Clean with a tool such as a toothbrush.
▶ When washing with water, dry off all water before reinserting.

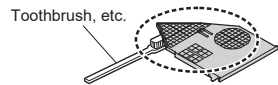

4. Reinsert the deodorizing filter.

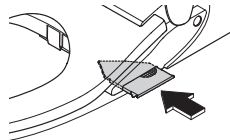

Push firmly until a click sound is heard.

5. Turn the power "ON". (→Page 40)
▶ The "Power" LED illuminates.

Drain Plug With Water Supply Filter

Approximately once every 6 months
If you think the water pressure has weakened

1. Close the shutoff valve. (→Page 56)
▶ The water supply stops.

CAUTION

Do not remove the drain plug with water supply filter while the shutoff valve is open.
Otherwise, water may leak out.

2. 
Press "Wand CLEAN" button.
• Release the pressure from the water supply pipe.

3. Turn the power "OFF". (→Page 40)

4. Open the toilet seat and lid.

5. Open the cover and remove the drain plug with water supply filter.

- 1) Insert a flat-head screwdriver in the hook of the cover to open it.

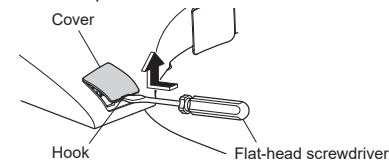

- 2) Loosen the drain plug with water supply filter with a flat-head screwdriver and then pull it.

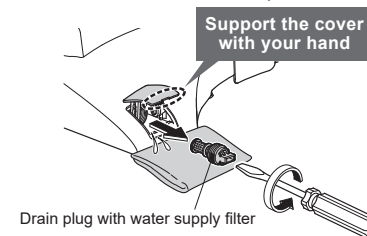

6. Clean the filter with a tool such as a toothbrush.
▶ Also, remove any dust from inside the hole of the drain plug with water supply filter.

7. Reinstall the drain plug with water supply filter and close the cover.
1) Insert the drain plug with water supply filter and use a flat-head screwdriver to tighten it securely.

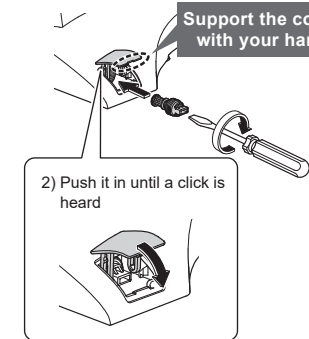

8. Turn the power "ON". (→Page 40)
▶ The "Power" LED illuminates.

9. Open the shutoff valve. (→Page 13)

Maintenance

Water Supply Filter (Bowl Unit)

Approximately once every 6 months

1. Remove the access cover (left).

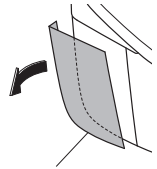

Note: There is an opening/closing tool (accessory) on the rear surface.

2. Close the shutoff valve. (→Page 56)
▶ The water supply stops.

CAUTION

Do not remove the water supply filter while the shutoff valve is open.
Otherwise, water may leak out.

Always perform this step

3. Press the "Wand CLEAN" button.
• Release the pressure from the water supply pipe.
(Otherwise, water may leak out.)

4. Turn the power "OFF". (→Page 40)

5. Loosen the cap of the water supply filter to remove the water supply filter.
▶ Use the opening/closing tool (accessory).

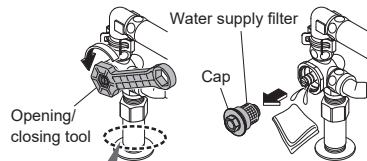

Hold the pipe with hands while loosening the cap.

6. Remove the water supply filter from the cap and clean it with a toothbrush or similar instrument.

Attention

Do not use detergent.
Do not apply excessive force to the water supply filter.
Otherwise, deformation may occur.



7. Install the water supply filter to the cap, then tighten the cap with the opening/closing tool.

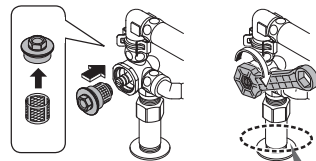

Hold the pipe with hands while tightening the cap.

8. Open the shutoff valve. (→Page 13)
▶ Check that there are no leaks in the shutoff valve or plumbing connections.

9. Mount the opening/closing tool to its original position and reinstall the access cover.
▶ Attach the left access cover so that there are no gaps between it and the bowl unit top / sides.

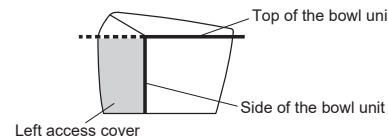

10. Turn the power "ON". (→Page 40)
▶ The "Power" LED illuminates.

What to Do?

If the water does not flow due to a power outage (when water failure hasn't occurred)

The bowl unit can be flushed with the manual water supply cord (orange) and manual water storage cord (white).

Watch video

If the water does not flow due to a power outage

<https://youtube.com/playlist?list=PL8JONSGBXLCS5fHWTMZ13wVNHnjLbYvU>

*May incur communication charges.

*You may not be able to watch the video depending on your environment.



Manual water supply cord (orange)

Manual water storage cord (white)

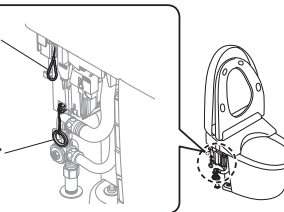

1. Remove the access cover (left).

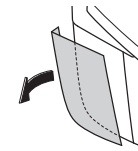

2. Open the toilet seat and lid.

3. Operate the manual water supply cord (orange) to supply water to the bowl unit.

- 1) Pull the manual water supply cord (orange) to its stop position.

Pull it



Water starts to be supplied

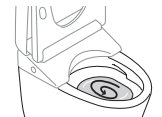
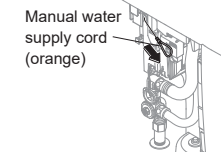

- 2) Release the manual water supply cord (orange).

Release it

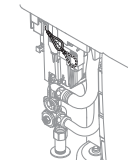

4. Operate the manual water storage cord (white) to raise the water level in the bowl unit and drain the water in the bowl unit.

- 1) Pull the manual water storage cord (white) to its stop position and hold it.

Pull it (The water level in the bowl unit rises.)



Raise the water level to the top of the water outlet.

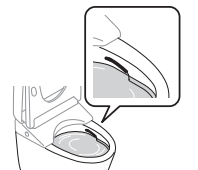
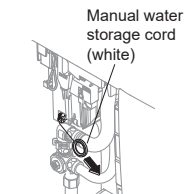

What to Do?

2) Release the manual water storage cord (white).

Release it
(The water in the bowl unit drains and the water level drops.)

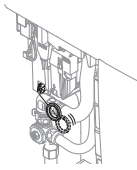

Note: Continuously pulling the manual water storage cord (white) may flood the bowl unit.

Attention

If the water in the bowl unit does not drain after releasing the manual water storage cord (white), the bowl unit may be clogged.

Pull the manual water supply cord (orange) to its stop position, release it, and fix the bowl unit. (→Page 42)
Water may overflow.

Always perform this step

5. When the water level in the bowl unit drops to the original level, operate the manual water supply cord (orange) to stop supplying water to the bowl unit.

Attention

If the waste material does not flush down completely, repeat the procedure from step 3.

1) Pull the manual water supply cord (orange) to its stop position.

Pull it

Manual water supply cord (orange)

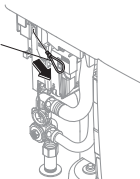

2) Release the manual water supply cord (orange).

Release it

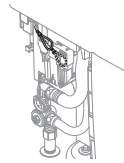

Check that water has stopped being supplied to the bowl unit.

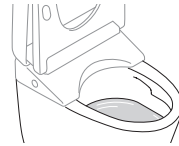

Attention

The manual water supply cord (orange) is pulled to its stop position to change whether to supply water to the bowl unit or stop it.

Be sure to pull the manual water supply cord (orange) to its stop position to stop supplying water to the bowl unit.

6. Attach the left access cover.

▶ Attach the left access cover so that there are apparently no gaps between it and the bowl unit top / sides.

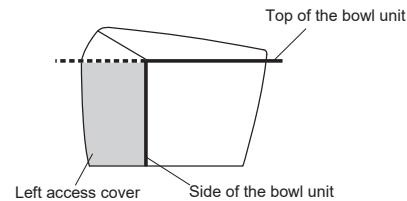

Attention

When power is restored, be sure to perform a "Flush".
To prevent waste from remaining in the discharge pipe.

You can also flush the bowl unit with a bucket. (→Page 51)

If the water does not flow due to a water service interruption

1. Use a bucket to flush the bowl unit. (About 6–8 L)

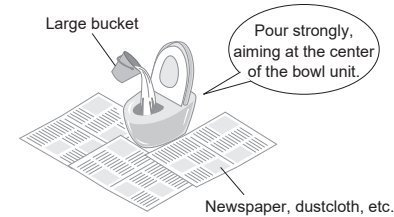

2. If the water level is low after flushing, add more water. (Until the water level does not rise further.)
▶ Prevents odors.

Attention

Before starting work, turn "Auto flushing" OFF. (→Page 27)

When the water supply is restored, make sure to first use water in the bath or kitchen (not with this product) to remove air from the water supply pipes.

Otherwise, air or foreign objects may enter this product, causing failure.

After that, be sure to perform a full flush.
To prevent waste from remaining in the drain pipe.

If you cannot operate with the remote control

Flush is also possible using the buttons on the right side of top unit.

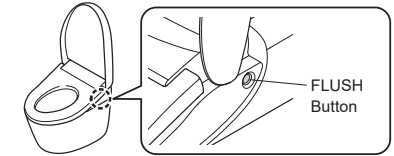

If the low battery warning mark " " on the surface of the remote control is flashing, please replace the batteries.

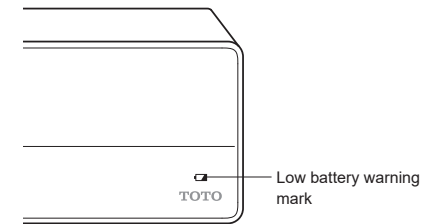

What to Do?

Replacing the batteries

1. Turn the power "OFF". (→Page 40)
2. Remove the remote control from the hanger. (→Page 12)
3. Open the battery cover and replace with two new AAA batteries. (→Page 12)
 - ▶ The low battery warning mark is unilluminated.
4. Mount the remote control in the hanger. (→Page 12)
5. Turn the power "ON". (→Page 40)
 - ▶ The "Power" LED illuminates.

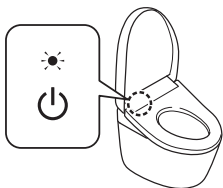

Attention

"ON" and "OFF" settings of the functions such as the energy saver function may be canceled when the batteries are replaced. Set them again.

Freeze Damage Prevention

When the ambient temperature is likely to drop to 0 °C or lower, take measures to prevent freezing.

Attention

When the ambient temperature is likely to drop to 0 °C or lower, do not use the energy saver feature.

Otherwise, the product may break down.

Warm the bathroom or take measures against freezing so that the ambient temperature does not drop below 0° C.

Before starting to work, set "Auto flushing" (→Page 27) and "Auto open/close" (→Page 30) to "OFF".

How to Freeze Damage Prevention (Dynamic mode)

This function runs the water for the bowl unit and top unit automatically at a fixed interval in order to prevent freezing.

How to Set

1. Turn "Anti freezing" ON with the remote control. (→Page 36)
 - ▶ The "Power" LED flashes.
 - The toilet flushes at intervals of about 10 minutes.
 - About 50 ml of water comes out from near the wand at intervals of about 5 minutes. (The wand remains retracted.)

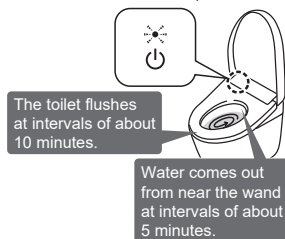

Long Periods of Disuse

If the toilet is in a location you will not visit for a long time, drain the water.

The water in the tank may cause malfunctions or become contaminated and cause skin irritation or other problems.

(The water may freeze, causing damage to the product.)

Attention

When there is a risk of freezing, take measures to prevent freezing. (→Page 52)

Otherwise, the product may break down.



Note: Do not drain water when the top unit is lifted up with the "Cleaning lift". (→Page 43)

How to drain the water

1. Close the shutoff valve. (→Page 56)
 - ▶ The water supply stops.

CAUTION

Do not remove the drain plug with water supply filter while the shutoff valve is open. Otherwise, water may leak out.

2.  Press "Full flush" button on the remote control to drain the tank.*1
3.  Press "Wand CLEAN" button.
 - Release the pressure from the water supply pipe.

4. Turn the power "OFF". (→Page 40)

5. Drain the pipe.
 - 1) Open the toilet seat and lid.
 - 2) Insert a flat-head screwdriver in the hook of the cover to open it.

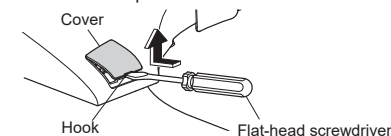

- 3) Loosen the drain plug with water supply filter with a flat-head screwdriver and then pull it.

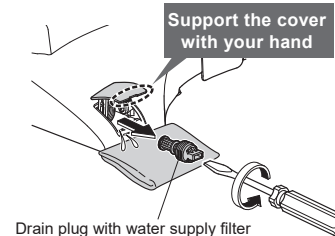

Drain plug with water supply filter

6. Reinstall the drain plug with water supply filter and close the cover.
 - 1) Insert the drain plug with water supply filter and use a flat-head screwdriver to tighten it securely.

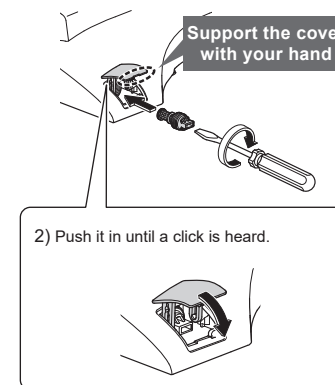

- 2) Push it in until a click is heard.

*1 If "Auto flush lid closed" is turned ON, the toilet lid closes before flushing the bowl unit.

What to Do?

If water may get frozen

- ▶ Add antifreeze solution to the water in the bowl to prevent freezing.
(The antifreeze solution should not be flushed out. Collect it before using the toilet and dispose of it.)

To use the product again

- ▶ The water needs to be resupplied. (→See below.)

Resupplying the Water

1. Open the shutoff valve. (→Page 13)
 - ▶ Check that water is not leaking from a pipe or the top unit.
2. If the power is not on, turn the power ON. (→Page 40)
 - ▶ The "Power" LED illuminates.
3. Discharge water from the wand.
 - 1) Pressing down the left side of the toilet seat,
 - 2)  Press "Rear washing" button to discharge water from the wand.
 - ▶ Catch the water in a paper cup or other receptacle.
 - 3) Release your hand from the toilet seat

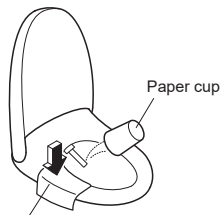

Soft cloth soaked in water
(to prevent scratching)



4. Press "Full flush" button.*¹

Attention

The bowl unit cannot be flushed when there is not enough water in the tank.
In this case, do not perform any operations.

- ▶ The LEDs on the main display flashes while water is being supplied to the tank, and then changes to lit when water supply is complete. It takes about 80 seconds for water supply to complete. (The required time depends on the usage conditions such as the water supply pressure.)

If the remaining water has frozen and no water comes out

- ▶ Heat the inside of the bathroom, and warm the water supply hose and shutoff valve using a cloth soaked in warm water.



5. After the bowl unit fills with water, press "Full flush" button again.*¹

How to remove the operation guide

To remove, follow the procedure below.

1. Turn the power "OFF". (→Page 40)
2. Remove the remote control from the hanger. (→Page 12)
3. Remove the hanger and operation guide.

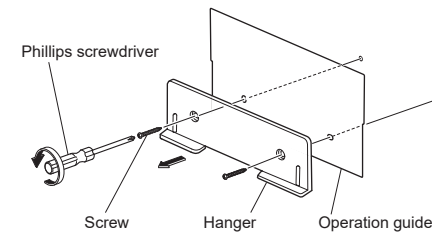

4. Screw the hanger on the wall.

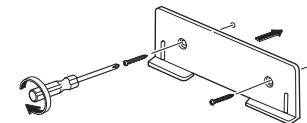

5. Mount the remote control in the hanger. (→Page 12)

6. Turn the power "ON". (→Page 40)
 - ▶ The "Power" LED illuminates.

To install back the operation guide, follow the procedure above.

- ▶ Install the operation guide at step 4.

*1 If "Auto flush lid closed" is turned ON, the toilet lid closes before flushing the bowl unit.

Troubleshooting

First, try the actions described on Pages 56–66. If the problem persists, consult the installer, seller, or TOTO Service (→see contact information on the back cover).

CAUTION

If a water leak occurs, close the shutoff valve.

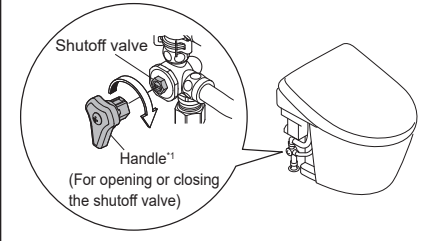

In the following case, switch the breaker on the distribution board to OFF and consult with TOTO customer service (→see contact information on the back cover).

"Power" LED, "Seat" LED, and "Energy saver" LED are flickering

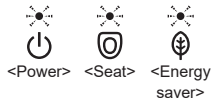

Please check first (A–C)

A: Is the Power LED illuminated?
Is the top unit working?

Is the "Power" LED on the main display flashing?

- ▶ The "Anti freezing" is set to "ON". (→Pages 36, 52)

Is the breaker on the distribution board turned on?

- ▶ Check whether there is a power outage or the breaker has turned "OFF".

Is the "Power ON/OFF" setting "OFF"?

- ▶ Switch it to "ON" with the remote control. (→Page 13 2-2.2)

B: Is the Energy saver LED lit?

- ▶ While the LED is lit, energy saver (→Pages 24, 25) is in operation, so the toilet seat temperature may be reduced or the heater may be turned off.

C: Is the remote control working?

Is the low battery warning mark  on the surface of the remote control flashing?

- ▶ Replace the batteries. (→Pages 12, 52)

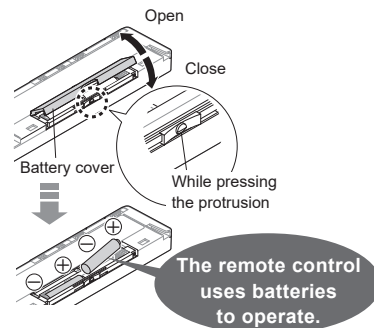

Is the remote control transmitter or the remote control receiver blocked?

- ▶ Remove obstructions, dirt, water droplets or any other blockages.

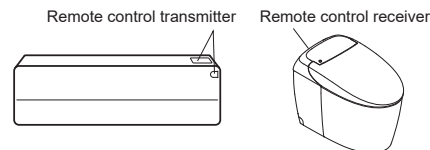

Rear Washing, Front Washing and Wand

Trouble

Please check

The wand (or washing water) does not come out

When the temperature is low, it takes time for the wand to come out after the remote control button is pressed because the water must be warmed up first.

Has the toilet been sat "ON" and used continuously for 2 hours or longer? (If so, operation is stopped for safety purposes.)

- ▶ Stand up from the seat and then use again.

If the water supply pressure drops significantly, for example if water is used elsewhere or if there is a water failure, the function may stop for safety.

- ▶ Turn the power OFF and wait about 10 seconds before turning the power ON again. (→Page 40)

If the above symptom reappears

There may be a malfunction.

- ▶ Consult with TOTO customer service (→see contact information on the back cover).

The seat switch will not turn on unless you sit on the seat properly.

- ▶ Sit back on the toilet seat. (→Page 8)

Are you using a toilet seat cover, a toilet lid cover or a seat for infants?

- ▶ Remove any covers. When using a seat for infants or a soft highchair, remove after each use. (→Page 9)



- ✎ Are you pressing "Wand CLEAN" button?

- ✎ When you press "Wand CLEAN" button, "EWATER+" comes out from the vicinity of the wand to clean the wand.

- ▶ To clean the wand with it extended, perform "Wand cleaning". (→Page 45)

The wand extends but the washing water does not come out / The washing water pressure is weak

Has a water failure occurred?

- ▶ Press "Stop" button on the remote control and wait until water service is restored.

Is the shutoff valve closed?

- ▶ Fully open the shutoff valve. (→Page 13)

Is the drain plug with water supply filter clogged with foreign matter?

- ▶ Clean the filter. (→Page 47)

Is the water pressure set to a low level? (→Page 17)

The washing water is cold

Is the warm water temperature set to "OFF" or a low level? (→Pages 20, 21)

When the temperature of the water supply or the bathroom is low, the water temperature may be low when first sprayed.

Stops in the middle of use

"Rear washing", "Rear soft washing" and "Front washing" stop automatically after 5 minutes of continuous use.

Does the seat switch have difficulty detecting?

- ▶ Sit back on the toilet seat. If you get up slightly from the seat, or sit forward on the seat, the seating switch may temporarily stop detecting your presence. (→Page 8)

*1 The handle is provided on the back side of the left access cover.

Troubleshooting

Rear Washing, Front Washing and Wand (continue)

Trouble	Please check
Water comes out unexpectedly from the wand	<p>Is the "Power" LED (green) on the main display flashing?</p> <p>▶ The "Anti freezing (dynamic mode)" is set to "ON". (Water comes out from near the wand at about 5 minutes intervals and the bowl unit flushes at about 10 minutes intervals.) (→Pages 36, 52)</p> <p>When you sit on the toilet seat, water comes out for several seconds while water is warmed up.</p> <p>Has the CLEAN indicator lit up in a cycle?</p> <p>▶ "Auto wand CLEAN" starts and the wand is cleaned. (→Page 16)</p>

Warm air drying

Trouble	Please check
The dryer temperature is low	Is the dryer temperature set to low level? (→Page 20)
Stops in the middle of use	<p>The feature stops automatically after about 10 minutes of continuous use.</p> <p>Does the seat switch have difficulty detecting?</p> <p>▶ Sit back on the toilet seat. If you get up slightly from the seat, or sit forward on the seat, the seating switch may temporarily stop detecting your presence. (→Page 8)</p>

Flushing

Trouble	Please check
For not flushing	<p>Is the shutoff valve fully open? (→Page 13)</p> <p>Has a power outage occurred?</p> <p>▶ You can use the manual water supply cord (orange) and manual water storage cord (white) to flush the bowl unit. (→Pages 49, 50)</p> <p>Has a water failure occurred?</p> <p>▶ Use a bucket to flush water. (→Page 51)</p>
The toilet does not flush even when the button of remote control is pressed	<p>Is the LEDs on the main display flashing?</p> <p>▶ The tank is filling with water. It takes about a minute for water supply to complete. (The required time depends on the usage conditions such as the water supply pressure.)</p>
The bowl unit does not clean automatically or timing is delayed (Auto flushing)	<p>Is "Auto flushing" set to "OFF"?</p> <p>▶ Set to "ON". (→Page 27)</p> <p>Even if "Auto flushing" is set to "ON", it is not available in the following instances.</p> <p>About 60 seconds after the toilet is flushed.</p> <p>▶ Wait about 60 seconds and flush the toilet with the remote control. (→Page 18)</p> <p>When the time spent sitting on the toilet seat or standing in front of the bowl unit is less than about 6 seconds.</p> <p>▶ Flush with the remote control. (→Page 18)</p> <p>When staying in front of the bowl unit after standing and using the toilet.</p> <p>▶ Step away from the toilet and wait for about 3 seconds.</p> <p>When water droplets or dirt are disrupting the body sensor.</p> <p>▶ Remove any dirt that is on the body sensor. (→Page 11)</p>

The bowl unit does not clean automatically or timing is delayed (Auto flushing)

The seat switch will not turn on unless you sit on the seat properly.

▶ Sit back on the toilet seat. (→Page 8)

The timing for the "Auto flushing" can be changed. (→Page 28)

The toilet flushes on its own

Is "Auto flushing" set to "ON"?

▶ You can turn it "OFF". (→Page 27)

Does the seat switch have difficulty detecting?

▶ Sit back on the toilet seat. If you get up slightly from the seat, or sit forward on the seat, the seating switch may temporarily stop detecting your presence. (→Page 8)

▶ Remove any dirt that is on the body sensor. (→Page 11)

Is the "Power" LED (green) on the main display flashing?

▶ The "Anti freezing (dynamic mode)" is set to "ON". (Water comes out from near the wand at about 5 minutes intervals and the bowl unit flushes at about 10 minutes intervals.) (→Pages 36, 52)

Waste material does not flush down completely

Is the shutoff valve fully open? (→Page 13)

Is the water supply filter clogged?

▶ Clean the filter. (→Page 48)

Is the water supply to the toilet disrupted by other running water fixtures?

▶ Cease using other fixtures and then flush the toilet.

Are the flush and light flush buttons being used correctly? (→Page 18)

▶ Full flush (for solid waste) : up to 10 m of toilet paper (single).

▶ Light flush (for liquid waste): up to 3 m of toilet paper (single).

Flushing may be difficult depending the consistency of the waste material.

▶ Flush the toilet again. If the bowl unit is not cleansed with a flushing, remove the stains with a brush or similar instrument. (→Page 42)

When the tank is filling, you cannot flush the toilet.

▶ Once the "Power" LED on the main display are lit and the tank fills up with water, flush the toilet.

A small amount of water flows into the bowl unit after the unit flushes

If the water supply pressure drops significantly, for example if water is used elsewhere or if there is a water failure, water is supplied so that the water surface in the bowl unit rises to a certain level.

If the above symptom reappears

▶ There may be a malfunction.

Consult with TOTO customer service

(→see contact information on the back cover).

Troubleshooting

Flushing (continue)

Trouble	Please check
Water keeps being supplied to the bowl unit	<p>Did you stop the water supply for flushing in case of power outage?</p> <p>▶ Pull the manual water supply cord (orange) to stop supplying water. (→Page 50)</p>
Some barium remains after flushing	<p>It may be difficult to flush down substances with a higher specific gravity than water, such as barium.</p> <p>▶ Flush the toilet again. If the bowl unit is not cleansed by flushing, clean it with a cleaning sponge or brush. (→Page 42)</p>
There is residue on the bowl unit surface	<p>Oil and other hard-to-see grime may stick to the bowl unit surface.</p> <p>▶ Clean with (non-abrasive) neutral toilet detergent. (→Page 42)</p>
The bowl unit does not flush with the manual water supply cord (orange) and manual water storage cord (white) (If the water does not flow due to a power outage)	<p>Did you pull the manual water supply cord (orange)?</p> <p>▶ Pull the manual water supply cord (orange) to start to supply water. (→Page 49)</p> <p>The water level may not be sufficient.</p> <p>▶ Continuously pull the manual water storage cord (white) until the water level in the bowl unit reaches the top of the water outlet. (→Pages 49, 50)</p>

Toilet Seat and Toilet Lid (Auto open/close)

Trouble	Please check
The toilet lid does not open automatically	<p>Is "Auto open/close" set to "OFF"?</p> <p>▶ Set to "ON". (→Page 30)</p> <p>Does the body sensor have difficulty detecting?</p> <p>▶ Remove any dirt that is on the body sensor. (→Page 11)</p> <p>Even when set to "ON", "Auto open/close" is not performed for about 15 seconds after the toilet seat or toilet lid is closed.</p> <p>When the toilet lid is closed with the remote control or by hand (To make the product more user-friendly, a time interval is set from when the lid is closed to when it will open next.)</p> <p>▶ Move away from the toilet and wait at least about 15 seconds before approaching the bowl unit again or open and close by hand. (→Page 18)</p> <p>Detection by the body sensor may be difficult when the room temperature exceeds 30 °C.</p> <p>▶ Use the remote control to open or close it. (→Page 18)</p> <p>Is "Auto open delay" set to [SET 2] or [SET 3]? (→Page 31)</p> <p>The toilet lid does not open automatically for about 10 to 60 seconds after the power is turned ON.</p> <p>▶ Use the remote control to open or close it. (→Page 18)</p> <p>Is a toilet lid or seat cover installed?</p> <p>▶ Remove any covers. (→Page 9)</p>

The toilet lid does not close automatically

Is "Auto open/close" set to "OFF"?

▶ Set to "ON". (→Page 30)

In the following cases, the toilet lid closes in about 5 minutes.

- When you did not sit on the toilet seat
- When you sat on the toilet seat for less than 6 seconds
- When you stood in front of the bowl unit for less than 6 seconds

If they do not close automatically even though "Auto open/close" is set to "ON", the body sensor may be detecting incorrectly.

▶ If there is a reflective object in front, such as a mirror or glass, move the reflective object or use a curtain or other object to block it. (→Page 8)

The toilet lid opens on its own

Is the body sensor directly exposed to sunlight?

▶ Do not directly expose the body sensor to sunlight, because it may cause incorrect detection. (→Pages 8, 9)

Is there a heater within the detection range of the body sensor?

▶ Do not place within the detection range of the body sensor. (→Pages 8, 9)

Is a urinal or wash basin also installed in the bathroom?

▶ The sensor may detect someone using the urinal, causing the toilet lid to open or close. (→Pages 8, 9)

When the bathroom door is open, the sensor may detect people who pass in front of the toilet. (→Page 8)

The toilet lid closes on its own

Is "Auto open/close" set to "ON"?

▶ You can turn it "OFF". (→Page 30)

Is "Auto close delay" set to [SET 1]? (→Page 30)

The seat switch will not turn on unless you sit on the seat properly.

▶ Sit back on the toilet seat. (→Page 8)

The toilet lid and toilet seat open at the same time

Is "Seat/lid" set to "Seat-lid"? (→Page 31)

Stops (or closes) while opening

If the toilet lid or seat hits an obstruction the first time it opens after the power is turned ON, it may stop (or close) partway during the next operation.

▶ Eliminate any obstructions and turn the power OFF. Turn the power ON again after about 5 seconds. Then press the "Opening and closing the toilet lid" button on the remote control. (→Page 18)

The open timing has changed

Detection by the body sensor may be difficult when the room temperature exceeds about 30 °C, such as in the summertime. (→Page 8)

Cannot open or close with the remote control

If it opens automatically.

▶ Check "Is the remote control working?" (→Page 56)

If automatic opening does not work either

- The toilet lid may not be mounted correctly.

▶ Mount them correctly. (→Page 44)

Incorrect detection may occur when operating under fluorescent lights.

Troubleshooting

Toilet Seat and Toilet Lid

Trouble	Please check
The toilet seat is cold	<p>Is the toilet seat temperature set to "OFF" or a low level? (→Pages 20, 21)</p> <p>Is energy saver in operation?</p> <p>The energy saver feature is on when the "Energy saver" LED is on and the "Power" LED is off on the main display. When you sit on the seat, the toilet seat heater is turned on temporarily and the seat is warmed in about 15 minutes. (→Pages 24, 25)</p> <p>▶ You can turn it "OFF" if the energy saver feature is "ON". (→Pages 26, 27)</p> <p>Have you been seated for a long time?</p> <p>After about 20 minutes of sitting, the temperature starts going down, and after about 1 hour, the toilet seat heater is turned "OFF".</p> <p>▶ Stand up from the seat and then use again.</p> <p>Is a toilet lid or seat cover installed?</p> <p>▶ Remove any covers. (→Page 9)</p>
The toilet seat and lid close on their own and then the bowl unit flushes	<p>Is "Auto flush lid closed" turned ON? (→Pages 28, 29)</p>

Auto flush lid closed

Trouble	Please check
"Auto flush lid closed" does not work	<p>Is "Auto flush lid closed" turned OFF?</p> <p>▶ Turn it ON. (→Pages 28, 29)</p> <p>If "Auto flush lid closed" is turned ON:</p> <p>Check the "Auto flushing" and "Auto open / close" settings. (→Pages 27, 30)</p> <p>Even if "Auto flushing" is turned ON, "Auto flush lid closed" does not activate in the following cases.</p> <p>About 60 seconds after the toilet is flushed.</p> <p>▶ Wait about 60 seconds and flush the toilet with the remote control. (→Page 18)</p> <p>When the time spent sitting on the toilet seat or standing in front of the bowl unit is less than about 6 seconds.</p> <p>▶ Flush with the remote control. (→Page 18)</p> <p>When staying in front of the bowl unit after standing and using the toilet.</p> <p>▶ Step away from the toilet and wait for about 10 seconds.</p>
The toilet lid closes too early or too late	<p>You can change "Auto flush delay" to modify the length of time before closing the toilet lid.</p> <p>(SET 1 / SET 2 / SET 3) (→Page 28)</p>

Energy Saver

Trouble	Please check
The Energy saver LED does not light up	<p>Has the power to the product been turned "OFF" or was there a power outage?</p> <p>The Energy saver LED on the main display may go off when the power is turned ON even if the energy saver feature is ON. It will turn on within about 24 hours since the setting is retained.</p>
The timer energy saver feature is not working	<p>Have the batteries in the remote control been replaced?</p> <p>"Timer energy saver" may be canceled when the batteries are replaced.</p> <p>▶ Set the timer energy saver again at the time you want to start it. (→Page 27)</p>
The auto energy saver+ or auto energy saver feature is not working	<p>Because this function takes several days learning the usage conditions before starting energy saver, the amount of energy saving may be low, depending on the frequency of use.</p> <p>▶ Check the energy saver setting. (→Pages 24, 25)</p>

Troubleshooting

Deodorizer

Trouble	Please check
The deodorizer seems to be not working	<p>Is "Deodorizer" set to "OFF"?</p> <p>▶ Set to "ON". (→Page 33)</p> <p>Even after sitting down, you do not hear operation sounds.</p> <p>▶ Sit back on the toilet seat.</p> <p>If you hear an operation sound from the deodorizer, but odors are not removed.</p> <p>▶ Clean the deodorizing filter. (→Page 46)</p>
A strange odour is emitted	<p>Are you using an air freshener or deodorizer that you purchased separately?</p> <p>Doing so may reduce the effectiveness of the product's deodorizer or cause strange odours.</p> <p>▶ Remove the air freshener or deodorizer.</p>
The auto power deodorizer feature is not working	<p>Is "Auto power deodorizer" set to "OFF"?</p> <p>▶ Set to "ON". (→Page 33)</p> <p>The auto power deodorizer starts about 10 seconds after you stand up from the toilet seat.</p>

Auto bowl CLEAN

Trouble	Please check
Pre-mist and aftermist do not work	<p>Is "Auto bowl CLEAN" set to "OFF"?</p> <p>▶ Set to "ON". (→Page 32)</p> <p>The following functions do not work when the toilet seat is open.</p> <p>Is "Seat/lid" of "Auto open/close" set to "Seat+lid"?</p> <p>▶ You can change it to "Lid". (→Page 31)</p> <p>The pre-mist does not work for about 90 seconds after the after-mist has finished.</p>
The pre-mist sprays out spontaneously	<p>If the washing functions (e.g., Rear washing and Front washing) are not used for about 8 hours, "Auto bowl CLEAN" starts and mist is sprayed inside the bowl unit.</p>

Lights

Trouble	Please check
The soft light, bowl light and CLEAN indicator do not light up	<p>Is the "Soft light", "Bowl light", or "CLEAN indicator" turned OFF?</p> <p>▶ Set to "ON". (→Pages 35, 36)</p>
The soft light lights permanently	<p>Is "Night light" ("Night mode") turned ON?</p> <p>▶ If it is turned ON, the Soft light lights permanently. You can also turn it OFF [STANDBY] (→Page 34)</p>
"Night light" (Night mode) is not activated	<p>Have the batteries in the remote control been replaced?</p> <p>"Night light" (Night mode) may be canceled when the batteries are replaced.</p> <p>▶ Set them again. (→Page 34)</p>

Others

Trouble	Please check
Water is leaking from the plumbing connections	<p>If any nuts in a connection are loose, firmly tighten them with a tool such as a monkey wrench.</p> <p>▶ If the water leak does not stop, close the shutoff valve and consult with TOTO customer service. (→see contact information on the back cover)</p>
The top unit is unstable	<p>There is clearance between the toilet seat cushion and the bowl unit for activating the seat switch.</p> <p>▶ When you sit on the toilet seat, the toilet seat subsides slightly to activate the seat switch. (→Page 8)</p>
Water splashes up when using the toilet	<p>The water in the bowl unit that is used to mask the smell of excrement is the cause of the splashing.</p> <p>▶ Adding a layer of toilet paper on the surface of the water can slightly dampen splashing.</p> <p>You can lower the bowl unit water level. (→Page 37)</p>
When flushing, you hear a squishing sound underneath the floor	<p>There are cases when the sound is made inside the discharge pipe because of the device to ensure water in the bowl unit after the unit flushes.</p>
When flushing, you hear a gurgling sound	<p>When the toilet is flushed together with waste material, the sound is a result of air, waste material and water being pulled through the system.</p>
There are black stain on or around the bowl unit	<p>Ammonia in urine may cause black stains.</p> <p>▶ If urine has splashed on the bowl unit or floor, wipe it immediately.</p>
The top unit makes a sound	<p>When sitting on the toilet seat</p> <p>If "Auto bowl CLEAN" is "ON", you may hear that pre-mist is spraying mist in the bowl unit to make it more difficult for dirt to adhere.</p> <p>▶ You can turn it "OFF". (→Page 32)</p> <p>When using the washing functions (Rear washing, Rear soft washing, or Front washing)</p> <p>You can hear the sound of the pump operating while washing water is being supplied.</p> <p>When moving away from the bowl unit after use</p> <p>When "Auto power deodorizer" is "ON", operation sounds are made while the deodorizing power increases for 60 seconds after you stand up from the toilet seat.</p> <p>▶ You can turn it "OFF". (→Page 33)</p> <p>If "Auto wand CLEAN" is "ON" and you use the washing functions (e.g., Rear washing and Front washing), you may hear that the wand is extended and cleaned with "EWATER+".</p> <p>▶ You can turn it "OFF". (→Page 32)</p> <p>If "Auto bowl CLEAN" is "ON" and you sit on the toilet seat and use the toilet, you may hear that mist of "EWATER+" is sprayed inside the bowl unit.</p> <p>▶ You can turn it "OFF" (→Page 32)</p> <p>You may hear that the wand is extended and the remaining water in the product is drained after "Auto wand CLEAN" and other functions are performed.</p>

Troubleshooting

Others (continue)	
Trouble	Please check
The top unit makes a sound	<p>When not using the product (e.g., at night) You may hear the following sounds if "Auto wand CLEAN" or "Auto bowl CLEAN" is "ON" and if you do not use the washing functions (e.g.,Rear washing and Front washing) for about 8 hours.</p> <p>"Auto wand CLEAN" : Sound of cleaning the wand with "EWATER+". : Sound of extending the wand and draining remaining water from the product after operation of functions.</p> <p>"Auto bowl CLEAN" : Sound and operating noise of spraying EWATER+ mist on the bowl unit.</p> <p>▶ You can turn it "OFF". (→Page 32)</p> <p>Operating noise may occur for extending the wand to prevent damage due to freezing by discharging the water remaining within the product.</p>
You feel air in the bowl unit when sitting on the toilet seat	<p>A mist is sprayed inside the bowl unit to make it more difficult for dirt to adhere when sitting on the toilet seat. You may feel air when a mist is sprayed.</p> <p>▶ You can turn it "OFF". (→Page 32)</p>
There is black or pink slime on the bowl unit surface	<p>It is a result of growth of airborne fungal spores or bacteria that feed on filth on the bowl unit.</p> <p>▶ Clean with (non-abrasive) neutral toilet detergent.</p>
There are water droplets on the bowl unit surface	<p>Condensation occurs when the humidity is high, and there is a significant difference between water and room temperatures.</p> <p>▶ Wipe off droplets with dry cloth. (Condensation can build up on condensation-proof bowls when the difference between room and water temperatures exceeds 15°C and the ambient humidity reaches 80%.)</p>
It takes a long time for the tank to fill	<p>Is the shutoff valve fully open? (→Page 13)</p> <p>Is the water supply filter or drain plug with water supply filter clogged? ▶ Clean the filter. (→Pages 47, 48)</p>
After the bowl unit is flushed, a bang is heard	<p>Water hammer has occurred in the pipes while the water is supplied or stopped.</p> <p>▶ Tighten the shutoff valve to reduce the water rate to an extent that does not affect a practical use of the toilet.</p>
The top unit cannot be operated through the remote control	<p>Follow the instructions "Please check first (A-C)". (→Page 56)</p> <p>The following conditions may affect the reception performance of the remote control, resulting in not being able to operate the top unit.</p> <ul style="list-style-type: none"> • When the room size, the layout of fixtures etc. interferes • When the color of the ceiling or walls is too dark, or their shape or material interferes • When there is a rack or cabinet installed on the wall behind the top unit • When an inverter lighting system is used <p>▶ Change the position of the remote control and try again.</p>

Specifications

オーストラリア向けの便器洗浄水量追加

Item	NEOREST RS
Rated power supply	AC 220 - 240 V, 50/60 Hz
Rated power consumption	843 - 852 W
Maximum power consumption	1431 - 1443 W (At a water supply temperature of 0 °C)
Type of water heater	Instantaneous type
Power cord length	1.2 m (For Singapore, 5.0 m)
Water protection level	IPX4
Bowl unit	
Flush volume	Floor drain : Full 3.8 L (For Malaysia, 4.0 L) (For Australia, 4.5 L), Light 3.0 L Wall drain : Full 4.5 L (For Malaysia, 5.0 L) Light 3.0 L
Water supply system	Direct supply, Pressurized supply
Flush type	TORNADO FLUSH
Bowl style	Elongated
Anti freezing	
Dynamic mode	Flush volume (dynamic) ¹⁾ : 29 L/h
Top unit	
Washing	
Spray volume ²⁾	Rear washing: Approx. 0.27-0.43 L/min Rear soft washing: Approx. 0.27-0.43 L/min Front washing: Approx. 0.29-0.43 L/min
Water temperature	Adjustable temperature range: OFF, about 30-40 °C
Heater capacity	1200 - 1428 W
Safety device	Temperature fuse
Backflow prevention device	Vacuum breaker, Check valve
Heated seat	
Surface temperature	Adjustable temperature range: OFF, about 28 - 36 °C (Auto energy saver: about 26 °C Auto energy saver+: OFF)
Heater capacity	45 - 54 W
Safety device	Temperature fuse
Deodorizer	
Method	O ₂ deodorization
Airflow volume	Normal mode: Approx. 0.09 m ³ /min Power mode: Approx. 0.16 m ³ /min
Power consumption	Normal mode: Approx. 1.6 W, Power mode: Approx. 4.0 W
Warm air dryer	
Warm air temperature ³⁾	Adjustable temperature range: about 35 - 60 °C
Airflow volume	Approx. 0.25 m ³ /min
Heater capacity	261 - 310 W
Safety device	Temperature fuse
Water supply pressure	Minimum required water pressure: (Dynamic, 10 L/min), Maximum water pressure: 0.75 MPa (Static)
Water supply temperature	0 - 35 °C
Working ambient temperature	0 - 40 °C
Dimensions	W 386 x D 690 x H 515 mm
Weight	About 40 kg (Top unit about 6 kg, Bowl unit about 34 kg)

When disposing of this product, please follow your local or state guidelines for proper disposal.

*1 The flush volume changes depending on water pressure.

*2 At 0.20 MPa (dynamic) water pressure

*3 Temperature around the warm air outlet measured by TOTO.

MEMO

MEMO

Safety Guidelines

A warm-water cleaning toilet seat is an electric appliance.

Continued use after malfunction occurs or use when its life-time is expired may deteriorate the electric components, producing smoke or resulting in a fire.

For safe use of the warm-water cleaning toilet seat

Periodical inspection is recommended.

•Please consider replacing the product when its life-time is expired.



If any abnormality of the product is observed, stop using it and consult the installer, seller or the contact listed on the back cover of this manual.

(A damaged product may cause a fire, electric shock, or may flood the floors with water.)

•Turn off the power immediately and close the shutoff valve.

Limited Warranty

LIMITED ONE YEAR WARRANTY

1. TOTO warrants its products to be free from manufacturing defects under normal use and service for a period of one (1) year from the date of purchase. This warranty is extended only to the ORIGINAL PURCHASER.
2. TOTO's obligations under this warranty are limited to repair or replacement, at TOTO's option, of products or parts found to be defective, provided that such products were properly installed and used in accordance with this OWNER'S MANUAL. TOTO reserves the right to make such inspections as may be necessary to determine the cause of the defect. TOTO will not charge for labor or parts in connection with warranty repairs or replacements. **TOTO is not responsible for the cost of removal, return and/or reinstallation of products.**
3. This warranty does not apply to the following items:
 - a) Damage or loss sustained in a natural calamity such as fire, earthquake, flood, thunder, electrical storm, etc.
 - b) Damage or loss resulting from any unreasonable use, misuse, abuse, negligence, or improper maintenance of the product.
 - c) Damage or loss resulting from removal, improper repair, or modification of the product.
 - d) Damage or loss resulting from sediments or foreign matter contained in a water system.
 - e) Damage or loss resulting from the quality of water in the region where the product is used.
 - f) Damage or loss resulting from improper installation or from installation of a unit in a harsh and/or hazardous environment.
 - g) Damage or loss resulting from electrical surges or lightning strikes or other acts which are not the fault of TOTO or which the product is not specified to tolerate.
 - h) Damage or loss resulting from normal and customary wear and tear, such as gloss reduction, scratching or fading over time due to use, cleaning practices or water or atmospheric conditions.
4. This warranty gives you specific legal rights. You may have other rights which vary from country to country.
5. To obtain warranty repair service under this warranty, you must take the product or deliver it prepaid to a TOTO service facility, together with a letter stating the problem, or contact a TOTO distributor or product service contractor, or directly to TOTO sales office. If, because of the size of the product or nature of the defect, the product can not be returned to TOTO, receipt by TOTO of written notice of the defect shall constitute delivery. In such case, TOTO may choose to repair the product at the purchaser's location or pay to transport the product to a service facility.

WARNING! TOTO shall not be responsible or liable for any failure of, or damage to, this Product caused by either chloramines in the treatment of public water supply or cleaners containing chlorine (calcium hypochlorite).

NOTE: The use of a high concentrate chlorine or chlorine related products can seriously damage the fittings. This damage can cause leakage and serious property damage.

THIS WRITTEN WARRANTY IS THE ONLY WARRANTY MADE BY TOTO. REPAIR OR REPLACEMENT AS PROVIDED UNDER THIS WARRANTY SHALL BE THE EXCLUSIVE REMEDY AVAILABLE TO THE PURCHASER. TOTO SHALL NOT BE RESPONSIBLE FOR LOSS OF USE OF THE PRODUCT OR FOR OTHER INCIDENTAL, SPECIAL, OR CONSEQUENTIAL DAMAGE OR EXPENSES INCURRED BY PURCHASER, OR FOR LABOR OR OTHER COSTS DUE TO INSTALLATION OR REMOVAL, OR COSTS OF REPAIRS BY OTHERS, OR FOR ANY OTHER EXPENSE NOT SPECIFICALLY STATED ABOVE. EXCEPT TO THE EXTENT PROHIBITED BY APPLICABLE LAW, ANY IMPLIED WARRANTIES, INCLUDING THAT OF MERCHANTABILITY OR FITNESS FOR USE, ARE EXPRESSLY LIMITED TO THE DURATION OF THIS WARRANTY. SOME STATES DO NOT ALLOW LIMITATIONS ON HOW LONG AN IMPLIED WARRANTY LASTS, OR THE EXCLUSION OR LIMITATION OF INCIDENTAL OR CONSEQUENTIAL DAMAGE, SO THE ABOVE LIMITATION AND EXCLUSION MAY NOT APPLY TO YOU.